

Panasonic®

使用说明书 Operating Instructions

(家用) 电动按摩椅
(Household) Massage Lounger

型号 EP-MA01
Model No.

简体中文	C2
English	E2



在使用本按摩椅之前，请仔细阅读使用说明书。

Before operating this unit, please read these instructions completely.





目录

重要的安全事项	C3
接地说明	C6
规格	C6
各部位名称和功能	C7
设置按摩椅	C9
每次按摩之前（检查设备）.....	C12
选择菜单并开始按摩.....	C14
使用“自动程序”按摩	C15
使用“部位集中”按摩	C18
使用“随心选择”按摩	C19
使用小腿·脚部（温热气囊）按摩	C21
结束按摩	C23
清洗及保养	C25
疑问解答（Q&A）.....	C26
故障检修	C29

重要的安全事项 必须遵守

下文列举的是使用中为防止人身、财产损害而必须严格遵守的安全事项。

■所有安全事项将根据因错误使用而导致危害或损害的程度，予以说明。

 警告	可能造成重伤或死亡后果的事项内容。
 注意	可能造成轻伤或财产损害的事项内容。

■请注意各安全事项前的符号。(下文为符号范例)



 绝对禁止事项。	 必须执行事项。
---	---

 **警告**



 必须遵守

- 正在接受治疗或有以下症状的人，在使用本机前，应咨询医师。
 (1)佩戴起搏器或其他易受电子干扰的体内植入型电子医疗器械的人
 (2)恶性肿瘤病人
 (3)心脏病病人
 (4)被查证丧失辨别温度能力的人
 (5)孕妇或刚完成分娩的人
 (6)因糖尿病等高度末梢循环障碍引起知觉障碍的人
 (7)骨质疏松症患者、脊椎骨折病人、患有扭伤或肌肉拉伤等急性疼痛性疾病的人
 (8)按摩部位受伤的人
 (9)体温 38℃ 以上(有发热症状)的人
 (例：急性炎症症状[如倦怠感、寒颤、血压变动等]强烈时、身体虚弱时)
 (10)必须静养或身体显著不适的人
 (11)脊椎异常或脊椎弯曲的人
 (12)患有椎间盘突出症的人
 (13)除上述之外，身体感觉特别不适的人
 不遵守此事项，恐发生事故或造成身体不适。
- 使用中感到身体异常、或使用后觉得没有效果时，请立即停止使用，并咨询医师。
 不遵守此事项，恐发生事故或造成身体不适。
- 按摩中或移动靠背、小腿·脚部按摩部时，请事先确认本机周围(本机后面、下面、前面和侧面)没有人或宠物。
 不遵守此事项，恐发生事故或造成伤害。
- 在使用本机前，一定要掀开靠枕和腰部衬垫，以检查按摩轮可行走部分的面料是否破损。
 (无论发现多么细小的破损，都请立刻停止使用，拔掉电源插头，并将本机送修。)
 在面料破损的情况下使用本机，可能引发受伤或触电的危险。
- 使用最初，请选择轻度按摩的“舒展放松”程序。
 ● 每次按摩请控制在 15 分钟内。
 ● 请将对身体同一部位的按摩控制在 5 分钟内。
 不遵守本事项，可能引起反效果或引发受伤的危险。
- 每次使用完毕，应将电源开关滑到“off”(关闭)位置，并将安全锁开关拨到“lock”(锁定)位置。取走安全锁开关键匙后，拔掉电源插头。
 不遵守本事项，可能因儿童顽皮引发事故或造成伤害。
- 将安全锁钥匙保管在儿童无法触及的地方。
 不遵守本事项，可能因儿童误食或顽皮引发事故或造成伤害。
- 请严格遵守插座和配线器具的使用规定。
 ● 请使用 220 V 交流电。
 (请勿在国外使用本品，或擅自连接变压器。)
 不遵守本事项，可能引发触电、机体故障或因过热导致火灾。
- 请务必将电源插头插到底，使其确实地插入插座中。
 不遵守本事项，可能引发触电或因过热导致火灾。
- 请定期清理电源插头上的灰尘等脏污。
 不遵守本事项，可能因湿气等原因引发绝缘不良，从而导致火灾。
 (请用干燥的抹布擦拭电源插头。)





! 警告

 禁止	<ul style="list-style-type: none"> ● 下列人员请勿使用本机。 被医生禁止按摩的人(例:患有血栓症、重度动脉瘤、急性静脉瘤、各种皮肤炎或皮肤感染症[包括患皮下组织炎症]的人等) 不遵守本事项,可能会导致病情恶化。
	<ul style="list-style-type: none"> ● 儿童禁止使用本机。此外,请勿让儿童在本机上玩耍,或者爬到小腿·脚部按摩部、座面、靠背或扶手上。 ● 请勿攀爬靠背或者扶手。 ● 请勿让不能表达自己意思的人或没有能力操作本机的人使用本机。 ● 按摩颈部时,请注意按摩轮的动向,请勿按摩前颈,请避免过重地按摩颈部。 不遵守以上事项,可能会引起事故或造成伤害。
	<ul style="list-style-type: none"> ● 请勿损坏电源线及电源插头。 (请避免此类行为:损伤、加工、强行弯曲、扭转、拉长电源线及电源插头,或将电源线及电源插头靠近发热器,或在电源线及电源插头上系重物、或任意捆绑。) 使用破损的电源线或电源插头,可能引起触电、短路或引发火灾。请到购买本品的商店或指定的维修中心咨询修理电源线或电源插头的方法。
	<ul style="list-style-type: none"> ● 请勿长时间使用脚部温热按摩。 不遵守本事项,有导致低温烫伤的危险。 ※即使温度相对较低(40℃~60℃),长时间接触某一处皮肤后,虽然没有明显烫或痛的感觉,仍有可能导致低温烫伤。
	<ul style="list-style-type: none"> ● 请勿损坏脚部温热部(加热器)。(参照第 C7 页) <ul style="list-style-type: none"> · 请勿以大头针或针头刺入脚部温热部。 · 请勿以刀划伤脚部温热部。 如内置加热器破损,可能导致火灾或引起触电。
 禁止湿手碰触	<ul style="list-style-type: none"> ● 请勿用沾湿的手插、拔电源插头。 不遵守本事项,可能引起触电。
 禁止私拆	<ul style="list-style-type: none"> ● 请勿擅自改造本机。请勿自行分解或修理本机。 不遵守本事项,可能引起火灾、机体运行异常或造成伤害。

! 注意

 必须遵守	<ul style="list-style-type: none"> ● 下列人员即使目前身体健康,也请咨询医师后再使用本机。 (1)因年龄增长而导致肌肉萎缩的人或身体纤瘦的人 (2)因骨头或内脏问题而感觉腰痛的人 (3)容易扭伤或容易瘀伤的人 (4)晕车、船或其它交通工具时,反应异常激烈的人 (5)过去曾被施予心脏手术或其它内脏手术的人 不遵守本事项,可能有损自身健康。
	<ul style="list-style-type: none"> ● 就坐前,请先确认本机各个部件之间没有异物。 (确认靠背、座面、小腿·脚部按摩部、靠枕、腰部衬垫内侧没有夹杂异物。) 不遵守本事项,可能因手、脚或其它物件被本机夹住,而引发事故、造成伤害或机体故障。
	<ul style="list-style-type: none"> ● 头部佩戴任何硬质饰物(如发卡等)时请勿使用本机。 不遵守本事项,可能有受伤的危险。
	<ul style="list-style-type: none"> ● 就坐前,确认按摩轮处在收纳位置。 ● 按摩途中若想离开座位,必须先停止按摩椅运作,再离开座位。 不遵守本事项,可能引发事故或造成伤害。
	<ul style="list-style-type: none"> ● 请勿扯电源线试图拔出电源插头,一定要握住插头本身将其拔出。 不遵守本事项,可能引发触电或短路。
	<ul style="list-style-type: none"> ● 为保证安全,请将本机接地插头连接至形状匹配的插座。 不遵守本事项,可能引发机体故障,或在漏电时发生触电。
	<ul style="list-style-type: none"> ● 移动本机前,必须把小腿·脚部按摩部的角度调节回最初位置。 不遵守本事项,可能造成伤害。
	<ul style="list-style-type: none"> ● 使用滑轮移动本机前,须先清空周围障碍物。将靠背调至最高位置后,抬起小腿·脚部按摩部及座面到略低于腰的位置,慢慢移动。(参照第 C10 页) 不遵守本事项,可能因机身翻到引发事故或造成伤害。

⚠ 注意

 必须遵守	<ul style="list-style-type: none"> ● 须将本机放置在水平面上使用。 不遵守本事项，可能因机身翻倒引发事故。
	<ul style="list-style-type: none"> ● 使用中不能动弹或发觉机体异常时，请立即停止使用，拔出电源插头，将本机送交指定维修中心检查修理。 不遵守本事项，可能引发触电或火灾。
	<ul style="list-style-type: none"> ● 因使用本品而产生出疹、红肿、发痒等症状时，请立即停止使用，并咨询医师。 不遵守本事项，可能引发事故或导致身体不适。
	<ul style="list-style-type: none"> ● 闲置一段时间后使用本品，请先重新阅读一遍产品使用说明书，并确认机体运作正常后，才开始使用。 不遵守本事项，可能引发事故或造成伤害。
	<ul style="list-style-type: none"> ● 如果使用滑轮移动本机，在地板上垫上垫子等。 不遵守本事项，可能会损伤地板。
 禁止	<ul style="list-style-type: none"> ● 请勿和其它治疗器械同时使用。 否则，可能造成事故或引起身体不适。
	<ul style="list-style-type: none"> ● 请勿让儿童使用遥控器托架的固定螺丝。 不遵守本事项，可能因儿童误食或顽皮引发事故或造成伤害。
	<ul style="list-style-type: none"> ● 请勿将头部、腹部或皮肤紧贴按摩轮。此外，请勿将手或脚伸入按摩轮之间。 ● 请勿将膝盖夹在小腿和脚部按摩部之间。 ● 勿在使用本机时入睡。此外，饮酒后请勿使用本机。 否则，可能导致事故或造成伤害。
	<ul style="list-style-type: none"> ● 请勿将手或脚伸入本机与小腿·脚部按摩部之间。 ● 按摩中，请勿突然拔出电源插头，或突然关闭电源开关。 否则，可能造成伤害。
	<ul style="list-style-type: none"> ● 未完全收起小腿·脚部按摩部时，请勿站立在其上。 本机若倾斜，可能引发事故或造成伤害。 小腿·脚部按摩部若碰撞地面，可能损坏地板。
	<ul style="list-style-type: none"> ● 勿将头、手臂或手等探入小腿·脚部按摩部各部件之间。 为了保证安全使用，在使用结束后，务必将小腿·脚部按摩部降低并调回最初位置。 否则，可能造成伤害。
	<ul style="list-style-type: none"> ● 请勿在已安装好的状态下拖动或推动本机。 否则，可能损坏地板。
	<ul style="list-style-type: none"> ● 请勿在有人入座时移动本机。 否则，可能因机身翻到引发事故或造成伤害。
	<ul style="list-style-type: none"> ● 移动本机时，请勿握住小腿·脚部按摩部塑料部分以外的部分。（参照第 C10 页） 该区域在移动中可能会发生滑动并造成伤害。
	<ul style="list-style-type: none"> ● 请勿在电热毯等加热设备上使用本机。 否则，可能引起火灾。
 禁止在有水的地方使用	<ul style="list-style-type: none"> ● 请勿在浴室或其它潮湿的地方使用本机。 否则，可能引发触电或机体故障。
 禁止沾湿	<ul style="list-style-type: none"> ● 请勿将水滴等物质撒在本机或遥控器上。 否则，可能引发触电、短路或引起机体故障。
 拔出电源插头	<ul style="list-style-type: none"> ● 清洗及保养本机或更换衬垫前，必须先从插座上拔出电源插头。 否则，可能引发触电或造成伤害。
	<ul style="list-style-type: none"> ● 停电时立刻拔出电源插头。 否则，在电力恢复时，可能引发事故或造成伤害。
	<ul style="list-style-type: none"> ● 不用时，一定要从插座上拔出电源插头。 否则，容易因灰尘或湿气导致绝缘品质降低，从而引发漏电或火灾。

接地说明

本机必须接地。如果本机发生功能失常，接地将为电流提供阻力最小的通道，以减少触电危险。本机装备了具有设备接地导线和接地插头的电源线。必须将该插头插入已完全依照当地代码和法令进行正确安装和接地的、合适的插座。

⚠ 注意

若设备接地导线的连接不当，则会导致触电危险。如果您对本机的接地是否正确存有疑问，请委托专业电工进行检查。即使本机附带的插头与插座不配，也不能对其进行改造。请委托专业电工安装合适的插座。

本机具有接地插头。请确认本机连接至具有与插头形状匹配的插座。本机不能使用转接插座。

规格

电源:	AC 220 V 50 Hz
消耗电力:	139 W
上半身按摩:	
可按摩范围 (上下方向):	约 64 cm (按摩轮移动的总距离约为 58 cm)
可按摩范围 (左右方向):	在使用本机过程中按摩轮间的间距 颈部、肩部、背部、腰部: 约 4 cm ~ 15 cm
可按摩范围 (前后方向):	按摩轮的突出量 约 6 cm
按摩速度:	捶拍: 约 285 个周期/分钟~495 个周期/分钟 (一侧) 揉按: 约 7 个周期/分钟~25 个周期/分钟 移动速度: 约 2 cm/s~4.5 cm/s
按摩间距:	与可按摩范围 (左右方向) 相同
气囊按摩:	
气压:	3: 约 32 kPa 2: 约 28 kPa 1: 约 20 kPa
自动关闭:	约 15 分钟后自动关闭
尺寸 (高×宽×长):	
未倾斜时:	约 105 cm × 78 cm × 150 cm
倾斜时:	约 82 cm × 78 cm × 176 cm
重量:	约 63 kg
包装箱尺寸 (高×宽×长):	约 83 cm × 86 cm × 179 cm
重量 (含包装箱):	约 82 kg
用户最大体重:	约 120 kg
执行标准:	GB4706.1 GB4706.10

对于体重 100 kg 或以上的人士，产品运作时可能产生更大的噪声，而且面料外罩可能磨损得更快。

尺寸图例

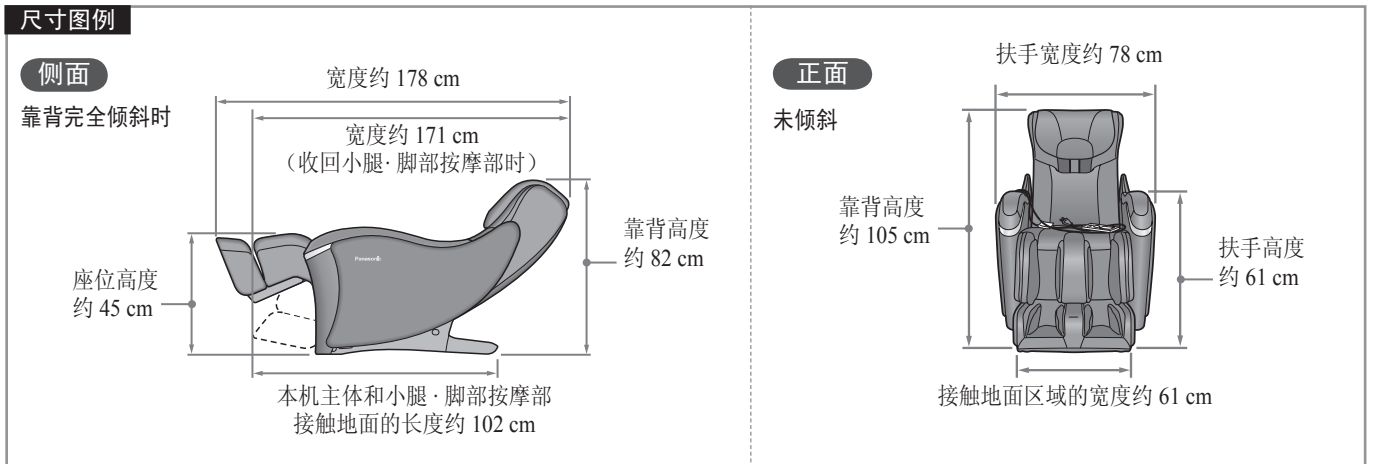

各部位名称和功能

主体

正面

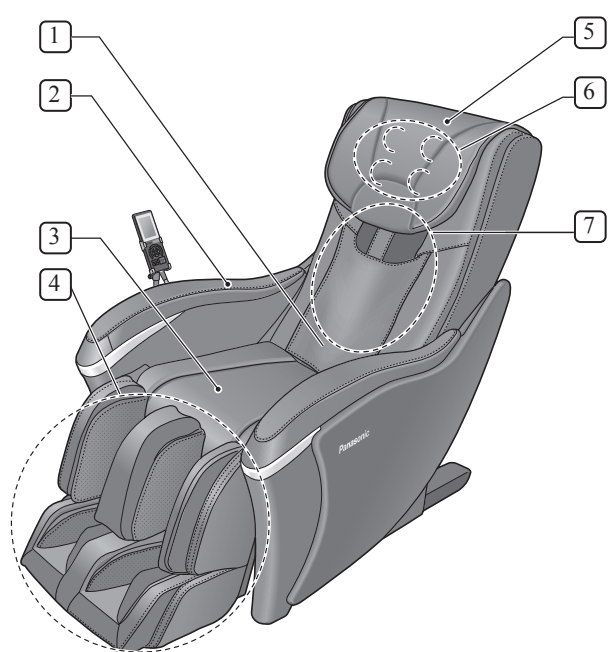

背面

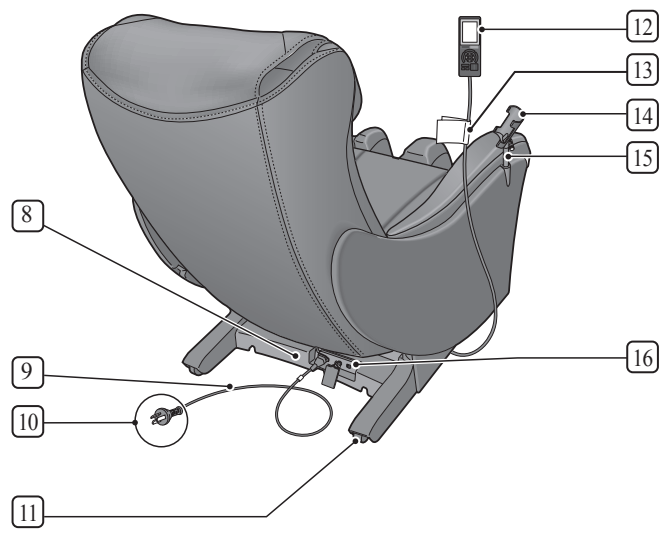

- 1 腰部衬垫
- 2 扶手
- 3 座面
- 4 小腿·脚部按摩部

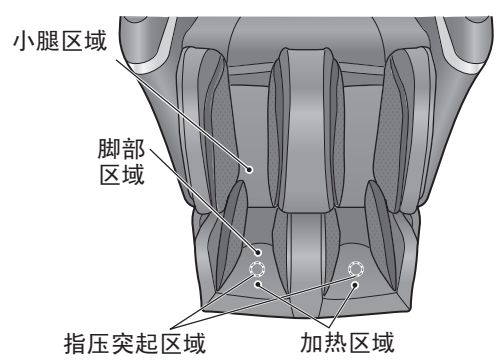

- 5 靠枕
- 6 按摩轮的收纳位置
- 7 靠背

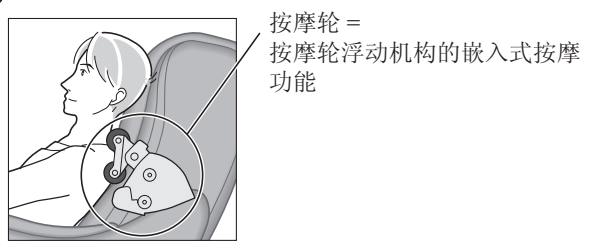

- 8 规格标签
- 9 电源线
 - 线长: 约 1.8 m

- 10 电源插头
- 11 滑轮
- 12 遥控器
- 13 安全警示标签
- 14 遥控器托架

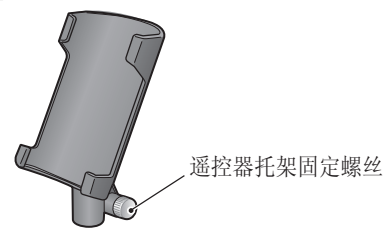

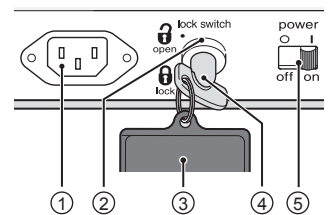

- 15 遥控器支架
- 16 电源开关部分
 - 参照第 C12 页
 - 出厂前安全锁开关设定为“open”（打开），电源开关设定为“on”（开）。

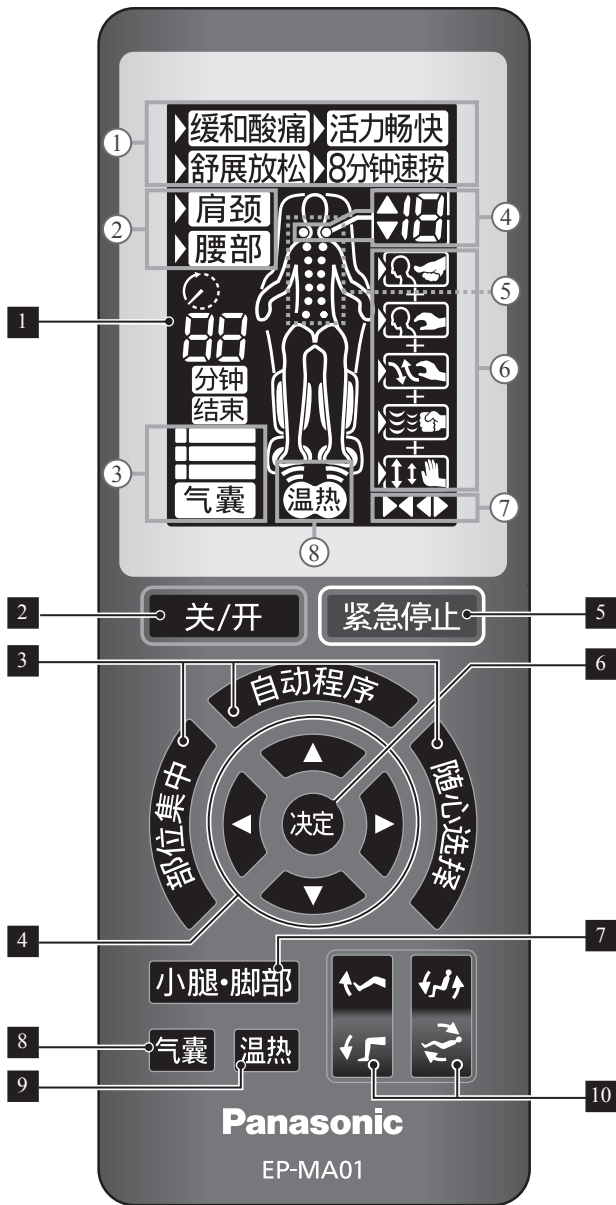

- 1 设备电源输入插口
- 2 安全锁开关
 - 以防儿童意外吞咽。
- 3 安全锁钥匙标签
- 4 安全锁钥匙
- 5 电源开关



液晶显示屏

- ① “自动程序”程序显示
 - 选择程序时：
当前选中程序前的▶标记会闪烁。
 - 按摩时：
显示当前程序。
- ② “部位集中”程序显示
 - 选择程序时：
当前选中程序前的▶标记会闪烁。
 - 按摩时：
显示当前程序。
- ③ 小腿·脚部气囊按摩强度显示
 - 使用三个级别显示当前小腿·脚部按摩的强度。
- ④ 肩部位置显示
 - 肩部位置调整模式时闪烁（约15秒）
 - 运行“自动程序”和“部位集中”程序时，常亮以显示肩部位置。
- ⑤ 按摩轮位置显示
 - 显示按摩轮当前的大约位置。
- ⑥ 按摩手法显示（参照第 C19 页）
- ⑦ 按摩轮间距
 - **随心选择** 仅对可以进行间距调整的操作进行调整。按摩过程中显示当前间距。
 较窄 /  较宽
- ⑧ 温热操作显示
 - 显示脚部温热的关/开状态。
 - 如果超过了设置的温度，温度操作显示屏上的双线就会从闪烁变为常亮。

- 1 液晶显示屏
 - 该图例为所有指示灯全部常亮时的图例。
 - 2 关/开按钮
 - 开启或关闭电源时使用的按钮。
 - 3 菜单选择按钮
 - 4 上/下 (▲/▼) — 调整按钮
左/右 (◀/▶) — 调整按钮
 - 5 紧急停止按钮
 - 需要立即停止按摩时，可按下该按钮。
 - 6 决定按钮
 - 7 小腿·脚部按摩关/开按钮
 - 开关小腿·脚部按摩。
- (参照第 C21 页)
- 8 小腿·脚部气囊强度按钮
 - 9 脚部温热关/开按钮
 - 10 倾斜角度调整按钮
小腿·脚部按摩部角度调整按钮

设置按摩椅

使用前（安装位置）

在将按摩椅取出包装箱之前，应先确定其安装位置。
 确保有足够空间可以对本机电源开关部分进行操作。（本机后面、两侧要保留约 10 cm 的空间。）

请与墙保持 3 cm 以上的距离。
 （靠背完全倾斜时）

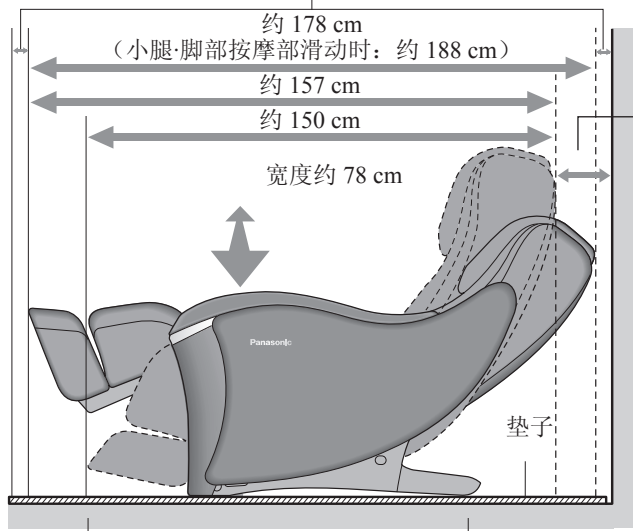

本机主体和小腿·脚部按摩部
 接触地面的长度约 102 cm



- 请勿在浴室或其它潮湿的地方使用本机。否则，可能引发触电或机体故障。
- 须将本机放置在水平面上使用。不遵守本事项，可能因机身翻到引发事故。
- 请勿在电热毯等加热设备上使用本机。否则，可能由于过热导致火灾、触电或人身伤害。

- 请勿将按摩椅暴露于阳光直射或高温环境下（如，加热设备前），因为这样可能导致按摩椅合成皮革褪色或硬化。
- 安装本机时，应确保主体的后背不会接触墙壁或其他任何物体。（否则，可能会导致损坏，如背部变形。）
- 为避免地板损伤，请在本机下铺上垫子。平铺垫子时，垫子的大小应足以盖住本机接触地板的范围与小腿·脚部按摩部接触地板的范围（至少 63 cm × 104 cm），如图所示。
- 安装本机时应靠近电源插座。

1. 打开包装箱，取出主体和所有附件。

确认包装箱内含有主体和各个附件。

主体

*图例所示为从包装箱中取出时的状态。

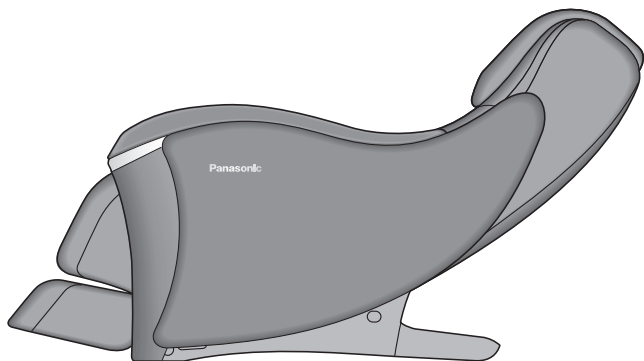

（靠背完全倾斜时）

附件

遥控器托架

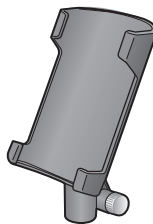

电源线



安全锁钥匙 1 枚



- 出厂前，安全锁钥匙插在电源开关部分的安全锁开关内。

2. 移动并安装本体

- 由于本机较重（约 63 kg），因此搬运时请小心，以免造成背部拉伤。（本机必须由两人或多人搬运。）
- 缓慢地放下本机，小心脚部被压伤。

- ⚠️
- 请勿在已安装好的状态下拖动或推动本机。否则，可能损坏地板。
 - 请勿在有人入座时移动本机。否则，可能因机身翻到引发事故或造成伤害。

抬起本机进行安装和设置

- 如果不正确握持本机，可能会摔落本机损坏地板。

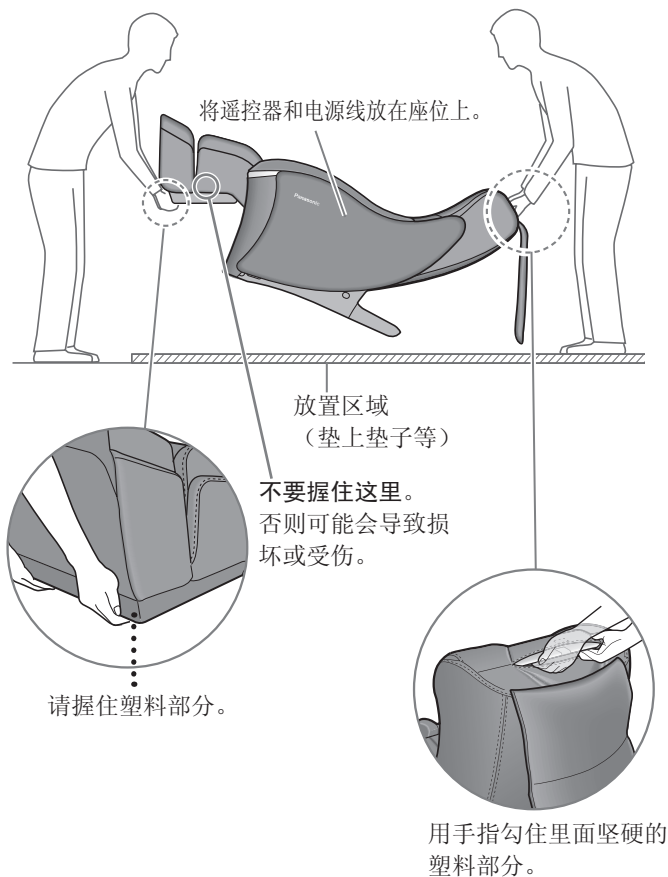

安装本机时靠背应远离墙壁。

确保靠背没有接触墙壁。

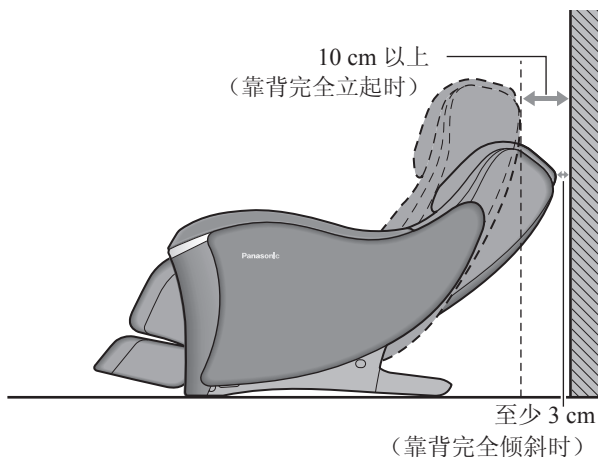

使用滑轮移动本机

- ⚠️
- 如果使用滑轮移动本机，在地板上垫上垫子等。不遵守本事项，可能会损伤地板。

执行第 C12 页上的步骤 1~5 后：

- 1) 按下  按钮

将靠背返回至其原始位置。

- 2) 将电源开关滑到“off”（关闭）位置，拔下本机插头。

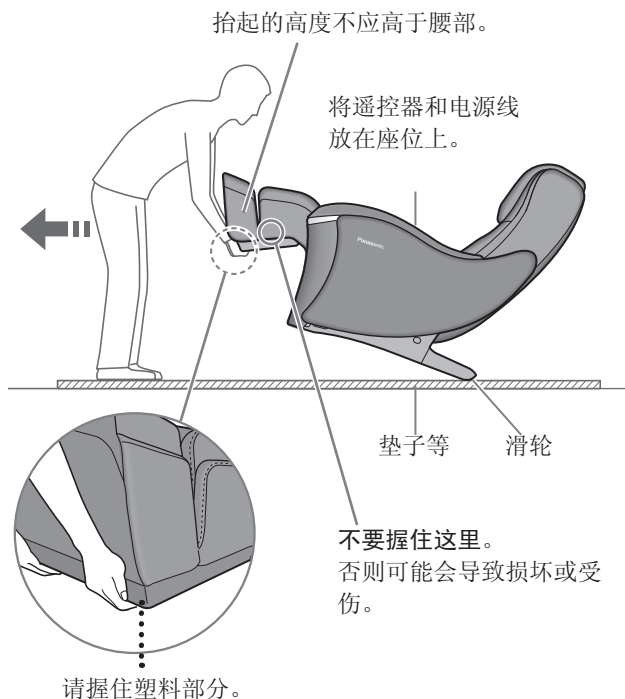

连接本机电源线

- 1) 检查电源开关部分的电气插座和电源线连接器上是否有灰尘或损坏。
- 2) 将连接器插入电气插座中。
- 3) 确保将连接器完全插入插座中。

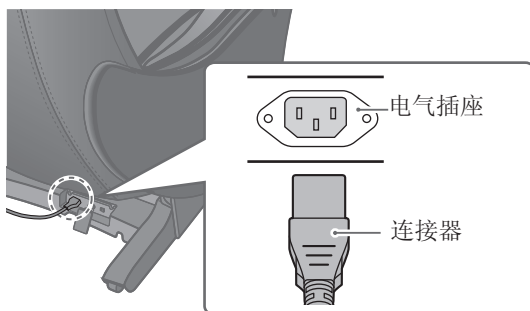

3. 组装

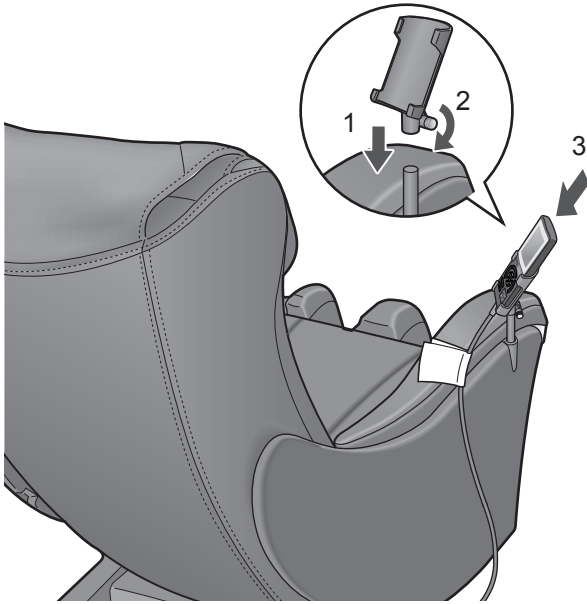

安装遥控器托架，然后将遥控器放入托架中。

- 1 将遥控器托架插入遥控器支架中，直至其嵌入到位。
- 2 使用遥控器托架固定螺丝进行固定
- 3 将遥控器放入遥控器托架中。

⚠️ • 请勿让儿童使用遥控器托架的固定螺丝。
不遵守本事项，可能因儿童误食或顽皮引发事故或造成伤害。

每次按摩之前（检查设备）

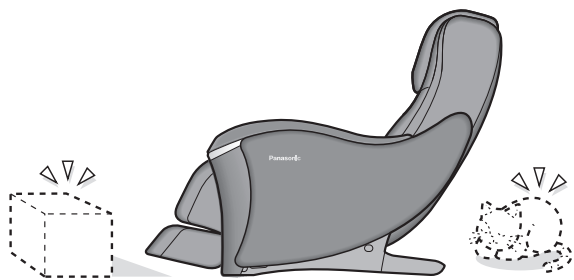

1 检查周围。

确定本机周围没有人、宠物及其它物体。

2 向上翻起枕头。



3 确保本机缝隙间没有异物。

⚠️ 就坐前，请先确认本机各个部件之间没有异物。
（确认靠背、座面、小腿·脚部按摩部、靠枕、腰部衬垫内侧没有夹杂异物。）

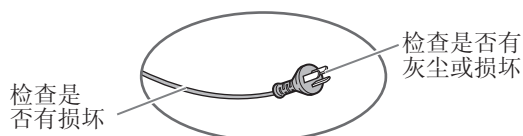
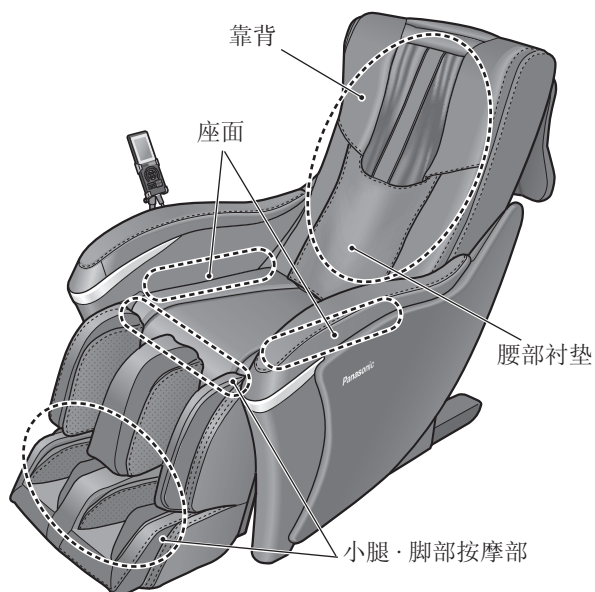

4 检查电源线和电源插头。

⚠️ 请定期清理电源插头上的灰尘等脏污。
不遵守本事项，可能因湿气等原因引发绝缘不良，从而导致火灾。（请用干燥的抹布擦拭电源插头。）

• 请勿损坏电源线及电源插头。
（请避免此类行为：损伤、加工、强行弯曲、扭转、拉长电源线及电源插头，或将电源线及电源插头靠近发热器，或在电源线及电源插头上系重物、或任意捆绑。）
使用破损的电源线或电源插头，可能引起触电、短路或引发火灾。请到购买本品的商店或指定的维修中心咨询修理电源线或电源插头的方法。

5 接通电源。

⚠️ 请务必将电源插头插到底，使其确实地插入插座中。
不遵守本事项，可能引发触电或因过热导致火灾。

• 请严格遵守插座和配线器具的使用规定。

• 请使用 220 V 交流电。
（请勿在国外使用本品，或擅自连接变压器。）
不遵守本事项，可能引发触电、机体故障或因过热导致火灾。

• 请勿用沾湿的手插、拔电源插头。
不遵守本事项，可能引起触电。

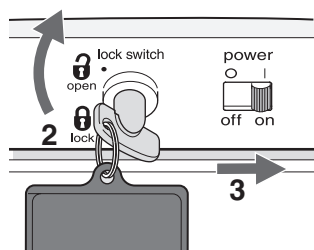
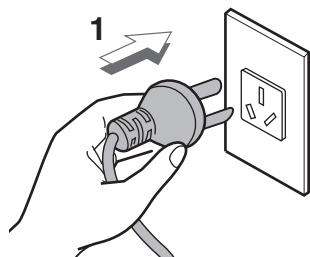

1 将电源插头插入电源插座。

2 将安全锁钥匙拨到“open”（开锁）的位置。

3 将电源开关滑到“on”（开启）的位置。

* 插入电源插头并开启电源后，遥控器的显示屏可能立刻就会亮起。

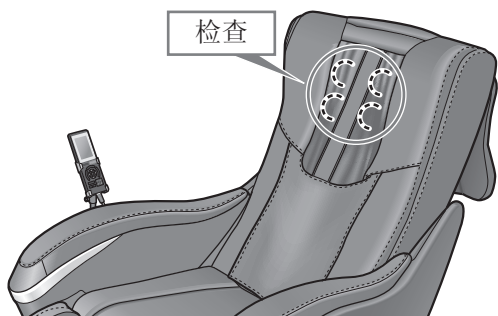

6 确认按摩轮处于收纳位置。

- ⚠️ • 就坐前，确认按摩轮处在收纳位置。不遵守本事项，可能引发事故或造成伤害。

按摩轮不处于收纳位置时

- 按下 **关/开** 按钮两次，将按摩轮返回至收纳位置。



7 检查本体上按摩轮的移动部位是否有裂缝。

- 翻起靠枕和腰部衬垫，检查按摩轮可行走部分的靠背面料是否破损。

- ⚠️ • 在使用本机前，一定要掀开靠枕和腰部衬垫，以检查按摩轮可行走部分的面料是否破损。
(无论发现多么细小的破损，都请立刻停止使用，拔掉电源插头，并将本机送修。)
在面料破损的情况下使用本机，可能引发受伤或触电的危险。



8 坐下并调整靠枕。

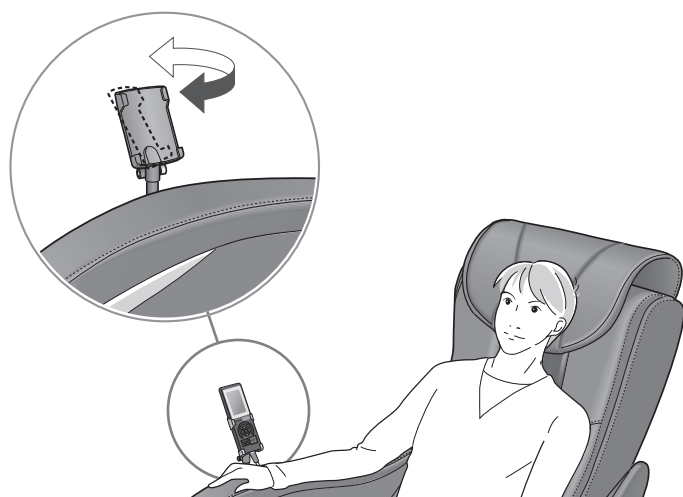

调整遥控器支架。

- 可左右进行调节。

9 选择按摩菜单。

(参照第 C14 页)

10 根据需要调整倾斜的角度。

选择菜单并开始按摩



- ⚠ 使用最初，请选择轻度按摩的“舒展放松”程序。
- 每次按摩请控制在 15 分钟内。
- 请将对身体同一部位的按摩控制在 5 分钟内。
- 不遵守本事项，可能引起反效果或引发受伤的危险。

- 使用 15 分钟后，推荐休息 10 分钟。
- 每天最多使用产品两次，最长 30 分钟。

1 按下 **关/开** 按钮，开启电源。

(开启电源后 3 分钟内，如果未选择菜单或未开始进行小腿·脚部按摩，电源将会自动关闭。)

2 从“自动程序”、“部位集中”和“随心选择”三个程序选择一个。

自动程序

自动程序

(参照第 C15 页)

有四个程序可供选择，可对肩部至腰部进行自动放松。

- 会同时开始小腿·脚部（温热气囊）按摩。

部位集中

部位集中程序

(参照第 C18 页)

可以选择“肩颈”或“腰部”。

- 会同时开始小腿·脚部按摩。

随心选择

随心选择

(参照第 C19 页)

可以选择您喜欢的手法按摩想要的部位。

您还可以单独开启小腿·脚部（温热气囊）按摩

想要开启小腿·腿部按摩时，

按下 **小腿·脚部** 按钮。

(参照第 C21 页上的步骤 2)

如果关闭了主体的电源或拔掉了电源插头，下次使用时按摩轮会自动移动。

按摩轮移动时，会出现右侧显示。这并非故障。

按摩轮移动一段时间后，可以正常使用本机。

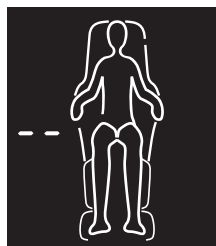

使用“自动程序”按摩

[程序选择模式]



按下 **自动程序** 按钮进入程序选择模式，然后选择自动程序中的按摩程序。
(进入程序选择模式后，三分钟内如果未执行任何操作，电源会自动关闭。)

1 按下 ▲▼◀▶ 选择程序。

从“缓和酸痛”、“舒展放松”、“活力畅快”和“8分钟速按”中进行选择。



闪烁的箭头会指向当前所选的程序。

不论选择哪个程序，小腿·脚部按摩会同时启动。

“自动程序”的程序特性

缓和酸痛

肩颈酸痛、腰部疲劳特别严重时，想要享受充分的全身按摩时可选。通过按摩轮向内揉按、向外揉按、颈部揉按、颈部推拿、捶拍等按摩手法，对自肩颈到腰部的区域进行充分有效的拉伸和揉按。

活力畅快

想要轻柔快速地缓和肩颈、腰部的酸痛时可选。以捶拍手法为中心，迅速而舒适地放松身体。这是一款能在按摩后让人感觉神清气爽的程序。

舒展放松

当想针对肩颈部酸痛和全身疲劳进行轻柔的放松按摩时选择，通过揉按手法和背部拉伸手法，以慢慢地放松全身。

8分钟速按

当想在短暂的休息时间进行一次快速的压力放松按摩时选择，按摩椅会在“缓和酸痛”程序的基础上用简短的八分钟程序集中按摩和放松身体容易感到僵硬和疲劳的区域。

2 选择程序，然后按下 **决定** 按钮。

1 本机会自动倾斜至正确的按摩位置。

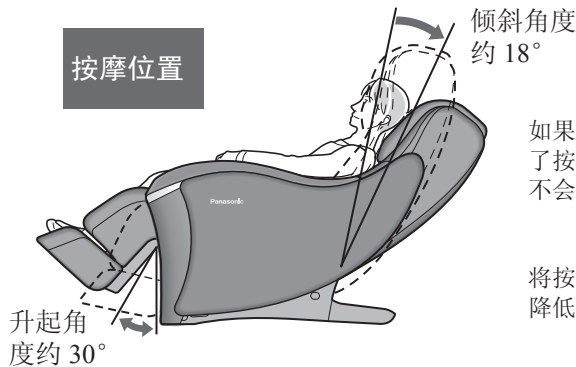

如果按摩椅倾斜的角度超过了按摩位置的角度，按摩椅不会自动返回正确的位置。

将按摩轮从其上部收纳位置降低。

2 将头部和肩部靠在靠背上。



按摩轮会慢慢向上移动，此时设备会发出一声“哗哗”声。

3 按摩轮升至与身体没有接触的时候会停止。

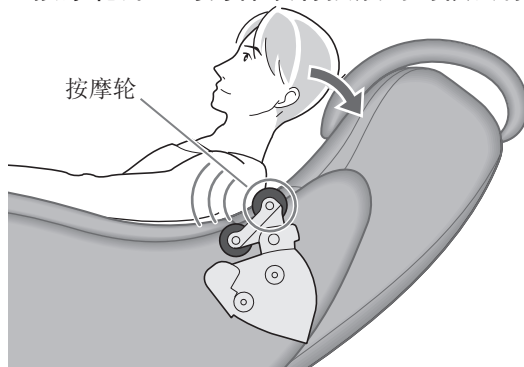

4 听到两声“哔哔”声，并看到液晶屏幕上  标志闪烁后，可自行调整按摩轮至最佳肩部位置。

[肩部位置调整模式]



<如何调整>



按下 ▲▼ 调整位置。
(每按一下，按摩轮移动约 1.5 cm。)

5 肩部位置匹配后，按下 **决定** 按钮，开始程序。

- 如果未按下 **决定** 按钮，程序会在 15 秒后自动运行。

注释

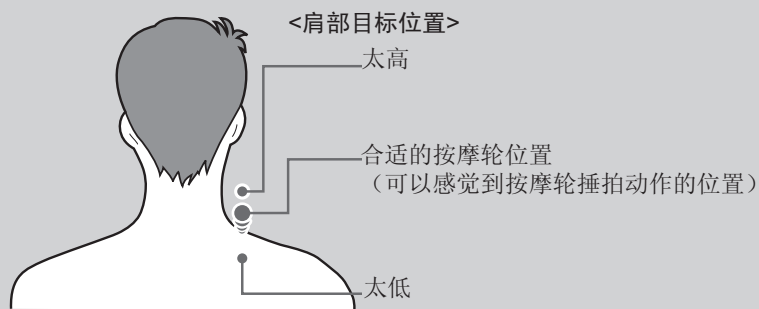

- 固定肩部位置后，根据人体高度与实际高度的差距，小腿·脚部按摩部可能会升起。
(以确保当同时使用小腿·脚部(温热气囊)按摩时，双脚可以够到脚底按摩区域。)
- 按摩运行中可随时调整肩部位置。
(进行“随心选择”按摩时不可调整。)

必须将头部和肩部靠在靠背上后开始按摩。

- 在肩部位置决定前，请勿让头部和肩部离开靠背。如果无法正常确定肩部位置，会显示错误消息(U10)并会结束操作。(参照第 C30 页)



自定义设定

- 当关闭小腿·脚部（温热气囊）按摩时

按下 **小腿·脚部** 按钮。

（参照第 C21 页）

- 要调整小腿·脚部（气囊）按摩的强度时

按下 **气囊** 按钮。

（参照第 C21 页）

- 当仅关闭加热功能时

按下 **温热** 按钮。

（参照第 C21 页）

更改按摩内容

- 要从“自动程序”按摩中选择其他程序时

按下 **自动程序** 按钮，然后选择其他程序。
上半身按摩会暂时停止。

（参照第 C15 页）

- 要更改为“部位集中”按摩时

按下 **部位集中** 按钮，然后选择程序。
上半身按摩会暂时停止。

（参照第 C18 页）

- 要更改为“随心选择”按摩时

按下 **随心选择** 按钮。
上半身按摩和脚部按摩会暂时停止。

（参照第 C19 页）

程序运行时的显示

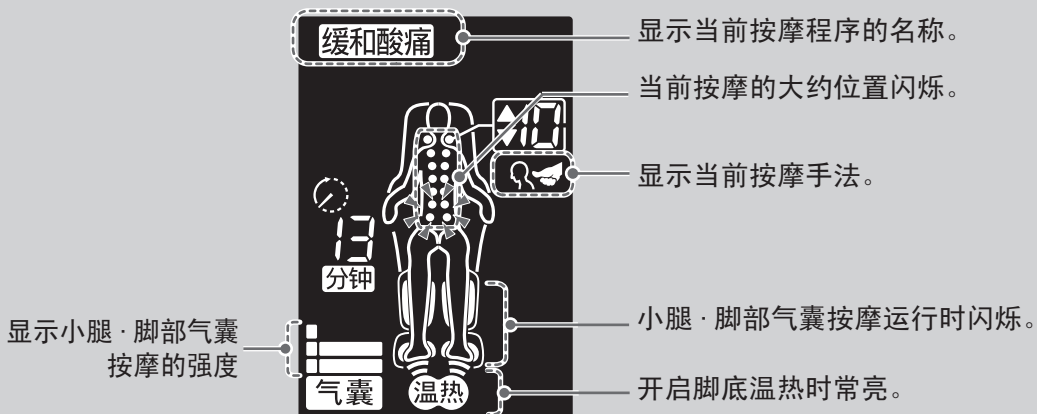

使用“部位集中”按摩

[程序选择模式]



按下 **部位集中** 按钮进入程序选择模式，然后选择部位集中下的按摩程序。

(进入程序选择模式后，三分钟内如果未执行任何操作，电源会自动关闭。)

1 按下 **▲▼** 按钮，选择程序。

选择“肩颈”或“腰部”。



闪烁的箭头会指向当前所选的程序。

不论选择哪个程序，小腿·脚部按摩会同时启动。

2 选择程序，然后按下 **决定** 按钮。

本机自动倾斜至正确的按摩位置。

(参照第 C15 页)

自定义设定

- 当关闭小腿·脚部（温热气囊）按摩时
按下 **小腿·脚部** 按钮。
- 要调整小腿·脚部（气囊）按摩的强度时
按下 **气囊** 按钮。
- 当仅关闭加热功能时
按下 **温热** 按钮。

(参照第 C21 页)

更改按摩内容

- 要从“部位集中”按摩中选择其他程序时

按下 **部位集中** 按钮，然后选择其他程序。
上半身按摩会暂时停止。

- 要更改为“自动程序”按摩时

按下 **自动程序** 按钮，然后选择其他程序。
上半身按摩会暂时停止。

(参照第 C15 页)

- 要更改为“随心选择”按摩时

按下 **随心选择** 按钮。
上半身按摩和脚部按摩会暂时停止。

(参照第 C19 页)

使用“随心选择”按摩

⚠️ 请将对身体同一部位的按摩控制在5分钟内。
不遵守本事项，可能引起反效果或引发受伤的危险。

按下 **随心选择** 按钮将切换为选择喜欢的按摩手法的模式。

(三分钟内如果未执行任何操作，电源会自动关闭。)

基本按摩（仅选择一个按摩手法使用时）

1 使用 ▲▼ 按钮选择按摩类别。

从“颈部推拿”、“颈部揉按”、“揉按”、“捶拍”和“拉伸”中选择按摩类别。



※▶在选择的种类旁闪烁。

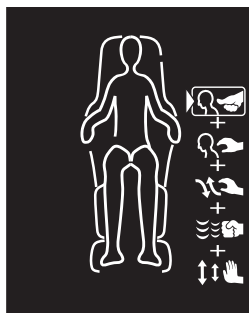

<按摩类别>

类别		手法
1	颈部推拿	颈部推拿
2	颈部揉按	颈部揉按
3	揉按	两侧按摩轮向内侧滚动，进行揉按
		两侧按摩轮向外侧滚动，进行揉按
4	捶拍	快捶
		慢捶
5	拉伸	全背拉伸
		局部拉伸

<注释>

如未在未选择按摩手法的情况下按下 **决定** 按钮，将选中与按下▶按钮1次时相同的按摩手法。

选择操作时，按下◀按钮可以反转选择的顺序。

2 使用 ◀▶ 按钮选择按摩手法。

* 选择的按摩手法会显示在方框中。



3 按下 **决定** 按钮。

本机将自动调整至按摩位置。
按摩将从所选的程序开始。
如果选择了“颈部推拿”、“颈部揉按”或“拉伸”时，操作开始时检查肩部的大约位置。
(小腿·脚部按摩不会同时开始。)

(参照第 C15 页)

结合使用多个按摩手法时

(示例) 当选择“揉按（向上揉按）”、“捶拍（快捶）”和“拉伸（局部拉伸）”时

1. 使用 ▲▼ 按钮选择按摩类别“揉按”。



2. 使用 ▶ 按钮选择“两侧按摩轮向外侧滚动，进行揉按”。
*选择的按摩手法会显示在方框中。



3. 使用 ▼ 按钮将箭头指向“捶拍”并使用 ▶ 按钮选择“快捶”操作。
*选择的按摩手法会显示在方框中。



4. 使用 ▼ 按钮选择“拉伸”，使用 ▶ 按钮选择“局部拉伸”。
*选择的按摩手法会显示在方框中。



5. 按下 **决定** 按钮开始运行程序。

<注释>

使用 ▲▼ 按钮选择按摩类别，如果按下了▶按钮，会显示可用的按摩类别组合。

[示例]
如果选择了“颈部推拿”，则可以选择“捶拍（快捶）”或“捶拍（慢捶）”。



在设定过程中取消选择的按摩手法时

按下▶按钮去除选择手法上的方框。

自定义设定

- 需要向上或向下调节按摩轮位置时



- 按下 ▲▼ 按钮进行调整。
- 每按一下，按摩轮移动约 1.5 cm。
 - 如果按住按钮，按摩轮会持续移动，直至松开按钮。

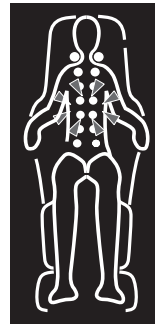

闪烁显示当前的大约位置。

- 要调整按摩轮间距

只有在“捶拍”和“拉伸”的手法时可用。



- 按下 ◀▶ 按钮进行调整。
- 可以调节按摩轮间距。

- 要同时使用小腿·脚部（温热气囊）按摩时
按下 **小腿·脚部** 按钮。

（参照第 C21 页上的步骤 2）

更改按摩内容

- 要从“随心选择”中选择其他手法时

按下 **随心选择** 按钮，然后从按摩类别中选择其他按摩手法。

（参照第 C19 页）

- 要更改为“自动程序”按摩时

按下 **自动程序** 按钮，然后选择程序。
上半身按摩会暂时停止。

（参照第 C15 页）

- 要更改为“部位集中”按摩时

按下 **部位集中** 按钮，然后选择程序。
上半身按摩会暂时停止。

（参照第 C18 页）

按摩时的图例



显示当前进行的动作。

“捶拍(慢捶)”和
“拉伸(全背拉伸)”的组合
按摩轮间距可以调整

使用小腿·脚部（温热气囊）按摩

如果用户皮肤比较敏感，请穿上厚袜。

1. 按下 **关/开** 按钮，开启电源。

2. 按下 **小腿·脚部** 按钮。

小腿·脚部按摩开始。

- 按摩开始时的强度级别为“2”且加热功能为“开”。
- 未使用上半身的按摩时，即使按下 **小腿·脚部** 也不可结束按摩。
- 单独按下 **气囊** 按钮，小腿·脚部气囊按摩开始。此时，温热功能并不开启。
- 无法单独使用 **温热**。



● 调整小腿·脚部按摩的强度



按下 **气囊** 按钮，可如右图调整气囊强度。

显示内容				
强度	0	1	2	3
	关闭	弱	强	

未使用上半身的按摩选项时，无法通过 **气囊** 按钮关闭小腿·脚部气囊按摩。

● 关闭“加热”功能



按下 **温热** 按钮时，可以切换温热的“开”、“关”状态。

如果没有运行 **气囊** 功能时，无法单独使用 **温热** 功能。

小腿·脚部按摩时间

单独使用小腿·脚部按摩时：按摩持续时间约为 15 分钟。
 配合上半身按摩使用时：上半身按摩结束时，小腿·脚部按摩也会同时结束。

对于体形较大的人士

调节足底按摩部分的滑动量，您的膝盖便不会抬起过高。

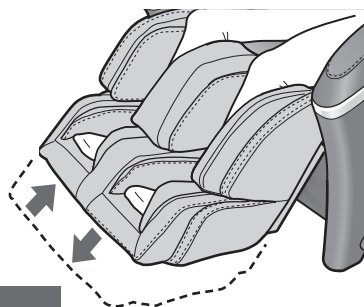

用足底将小腿·脚部按摩部推出。

稍微抬起脚，
则小腿·脚部按摩部复位。

小腿·脚部（温热气囊）按摩手法

小腿

会同时从两侧挤压小腿。

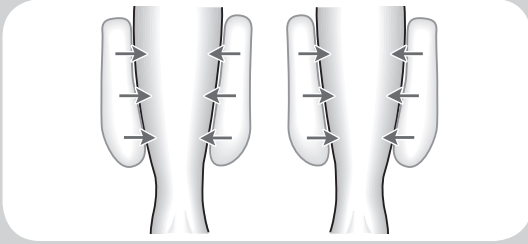

足底

确保将脚底放在指压突起物上。
会使用指压突起物按压脚底。

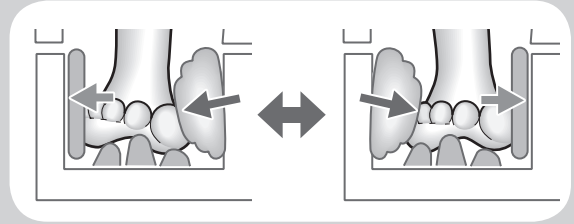

该操作会温暖脚底，让人感到舒适。
在腿上放置一块毯子等可以感到更加温暖。

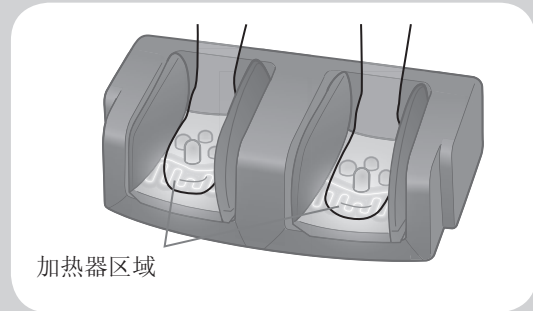

无法单独使用“温热”功能。

结束按摩

定时器功能

按摩开始后约 15 分钟，按摩将自动结束。

- 小腿·脚部按摩部将自动下降。
- 按摩轮移动到收纳位置。
- 靠背不会自动升起。

按两次 **关/开** 按钮，靠背将升起。

中断按摩

按下 **关/开** 按钮。

- 小腿·脚部按摩部自动降低，按摩轮恢复至收纳位置。
- 收回按摩轮后，靠背将升起。

如果您发现任何异常

按下 **紧急停止** 按钮。

- 所有操作将立即停止。
- 小心走下按摩椅，以防按摩椅翻倒。

缩回小腿·脚部按摩部

- ⚠** • 儿童禁止使用本机。此外，请勿让儿童在本机上玩耍，或者爬到小腿·脚部按摩部、座面、靠背或扶手上。不遵守以上事项，可能会引起事故或造成伤害。

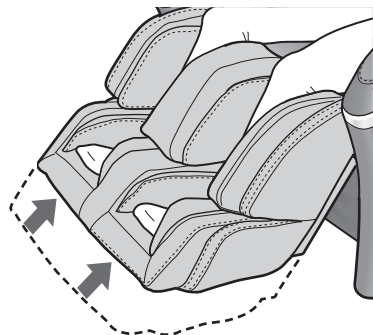

稍微抬起脚，
则小腿·脚部按摩部复位。

切断电源

- ⚠️ 将安全锁钥匙保管在儿童无法触及的地方。
不遵守本事项，可能因儿童误食或顽皮引发事故或造成伤害。
- 每次使用完毕，应将电源开关滑到“off”（关闭）位置，并将安全锁开关拨到“lock”（锁定）位置。取走安全锁钥匙后，拔掉电源插头。
不遵守本事项，可能因儿童顽皮引发事故或造成伤害。
- 请勿扯电源线试图拔出电源插头，一定要握住插头本身将其拔出。
不遵守本事项，可能引发触电或短路。
- 不用时，一定要从插座上拔出电源插头。
否则，容易因灰尘或湿气导致绝缘品质降低，从而引发漏电或火灾。
- 请勿让儿童使用遥控器托架的固定螺丝。
不遵守本事项，可能因儿童误食或顽皮引发事故或造成伤害。

1 将电源开关滑到“off”（关闭）位置。

2 将安全锁钥匙拨到“lock”（锁定）位置。

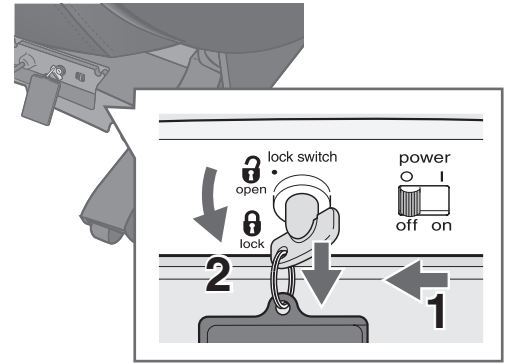

3 从电源插座上拔下电源插头。

4 安全锁钥匙必须存放在儿童无法触及的地方。

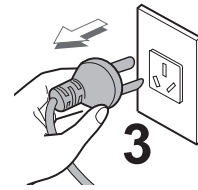

清洗及保养

⚠ •清洗及保养本机或更换衬垫前，必须先从插座上拔出电源插头。
否则，可能引发触电或造成伤害。

切勿使用诸如稀释剂、汽油、酒精等化学品。



合成皮革、塑料部位

常规清洁及维护

使用柔软的干布清洁掉灰尘和轻度脏污。

脏污时

1 将软布浸入水中或含 3% 至 5% 中性洗涤剂的热水中，然后彻底拧干。



2 清洁表面。

(轻拍清洁座椅面料部分、合成皮革。)



3 使用浸过清水且已彻底拧干的布料擦掉清洁液。

4 使用拧干的软布擦拭。

5 使其自然风干。

(不要使用吹风机等吹干表面。)



如果难以去除污渍





在步骤 1 中尝试以下方法。

<对于合成皮革>

请将在市面上购买的三聚氰胺泡棉浸入中性洗涤剂中，然后用它擦拭本机。

■ 疑问解答 (Q&A)

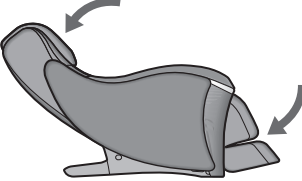
Q:	因为生病而经常出入医院的人可以使用本品吗？
A:	经常出入医院的人，请在与医生商量的前提下使用本品。 按摩即所谓“触压刺激”，即通过对肌肉进行压迫，缓解肌肉紧张，促进血液流动。根据不同的病因，按摩有可能造成病情恶化，因此请务必在和主治医师商量之后使用本品。（参照第 C3 - C5 页上的说明）
Q:	身高多少的人适合使用本品？
A:	根据体型的不同多少会有所差异。请大致参考下文使用本品。 身高低于 150 cm 的身型纤小者和身高超过 185 cm 的身型高大者在使用本品时，同时开启上半身按摩和小腿·脚部按摩后，可能会感到坐姿不适。 * 低身高者采用自动程序可能存在足底按摩不到的现象，可以采取抬高脚摩位置，并保持靠背倾斜角度为最高以改善按摩效果。
Q:	按摩时，枕头的正确使用方法是？
A:	按摩时，枕头的正确使用方法： • 通常情况下，应将枕头的位置调整到——枕头下端与耳朵相同高度。 • 当觉得颈部、肩膀的按摩力道不足时，可以将枕头向后翻起。在不使用枕头的情况下按摩。
	
Q:	按摩中感觉左右两边按摩轮的按摩力度有差异，要紧吗？
A:	由于机芯构造，在按摩过程中，确有可能感觉左右按摩轮的力度有差异。 为了能够模拟出最自然的按摩手法，本品机芯采用了允许左右按摩轮交替捶背的机芯构造。 在按摩过程中，左右按摩轮接触背部的具体位置可能稍有差异，从而导致了使用者产生左右两侧按摩力度有所不同的感觉。此时，本品本身并未发生故障。
Q:	感到背后的按摩轮在进行犹如“弹跳”般的动作，要紧吗？
A:	为了让按摩的感觉更为柔和，本机采用了按摩轮浮动机构技术。根据顾客的体型和坐姿，浮动机构自行微调，出现按摩轮进行犹如在“弹跳”般的动作，并非故障。
Q:	根据所选程序的不同，剩余时间表示内容会有所不同吗？
A:	是的，剩余时间表示的内容会呈现不同。 按下 关/开 按钮后，选定按摩程序时，按摩时间同时设定。 <div style="display: flex; align-items: flex-start;"> <div style="margin-right: 20px;"> <p>自动程序</p> <p>部位集中</p> <p>随心选择</p> <p>小腿·脚部</p> </div> <div> <p>除“8分钟速按”为8分钟外，其他按摩程序默认按摩时间均为15分钟。</p> <p>默认按摩时间均为15分钟。</p> <p>默认按摩时间为15分钟。</p> <p>只使用小腿·脚部按摩时，默认按摩时间为15分钟。与上半身按摩同时使用时，以上半身程序的按摩时间为准。</p> </div> </div> <p>* 在中途变更程序的情况下，由于已经设定过按摩时间，变更后的按摩程序只在剩余时间显示部指示的剩余时间内运行。</p>
Q:	按摩程序结束后靠背为什么没有恢复原状？
A:	依照已经设定好的按摩时间自然完成按摩后，为了让顾客继续保持放松舒适的坐姿，靠背不会竖起。 如果想让靠背恢复原状，可按遥控器上的 关/开 按钮两次，机器即可自动恢复初始状态。
Q:	脚底的指压是否过于用力？
A:	使用 气囊 将强度调至[1]。 或者降低小腿·脚部按摩部也可以减弱脚底的指压强度。

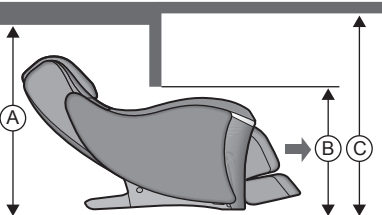
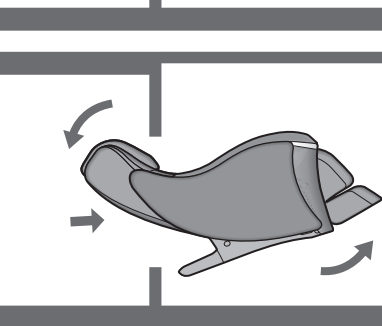
Q:	使用本品时，每月耗电量大概是多少？
A:	以一天 30 分钟（15 分钟× 2 次）、每天使用的频率来计算，一个月（按 31 天计算）本品耗电量约为 2 度。
Q:	有点在意按摩椅运作时发出的声音…
A:	按摩椅运作时产生的声音，一般是基于机芯构造而发出的。 （具体请参照第 C29 页上的说明） 如果机芯发出的声音非常大，请将按摩椅带到直营店或维修中心进行检测和修理。
Q:	脚部按摩时有噪音是否正常？
A:	本机脚部按摩是通过气囊挤压的方式进行按摩，机器内部有气泵组件进行充气工作，电磁阀组件进行充气和放气工作，有声音属于正常。 如果声音非常大，则按摩椅可能发生故障，此时，请将按摩椅带到直营店或维修中心进行检测和修理。
Q:	搬家时，有什么需要特别注意的地方？
A:	<p>请注意以下几点。</p> <ul style="list-style-type: none"> • 为了方便搬运，请先将按摩椅靠背倾斜到最低位置。 • 搬运前，请确认没有人坐在按摩椅上。 <p>1. 按下  按钮，接入电源。</p> <p>2. 按下  按钮，使靠背呈完全倾斜状态。</p>  <p>请长按这两个按钮，直到听到“哗哗哗”的提示音。 * 小腿·脚部按摩部收纳时，也会发出“哗哗哗”的提示音。请确认在靠背完全倾斜前，一直按住靠背倾斜按钮。</p> <p>3. 通过按下  按钮切断电源，拔掉电源插头。（参照第 C24 页上的说明）</p> <ul style="list-style-type: none"> • 在没有原装纸箱的情况下，为了防止机体划伤和搬运中的震动，请妥善使用其它包装辅材包裹本品。 • 在有原装纸箱的情况下，请先确认电源线未被缠绕在本机上，将电源线缠好放在座面上；搬运的时候，请注意电源线没有掉落且未与地面发生摩擦。
Q:	搬运本机时，如果无法顺利通过房门，应该怎么办？
A:	<p>请尝试以下方法。</p> <ul style="list-style-type: none"> • 搬入前，请先确认房门及其前后空间的宽度。搬入时，请务必小心不要让机身碰到门附近的墙壁和柱子。 • 当房门宽度小于79cm时，将本品横向搬入也可能通过房门。此时，请事先确认以下尺寸。 <p>1. 请将按摩椅横放后，一点一点通过房门。</p> <p>A) 进门前空间的宽度： 一侧墙壁到另一侧门框的宽度必须在 90 cm 以上</p> <p>B) 房门的宽度： 必须在 70 cm 以上</p> <p>C) 门内空间的宽度： 一侧墙壁到另一侧门框的宽度必须在 100 cm 以上</p>  <p>2. 一边旋转机身，一边通过房门。 * 当房门宽度在 70 cm 以下时，请勿自行开箱。 此时应联络 Panasonic 客户咨询服务中心，安排搬入事宜。（请参考右图）</p> 

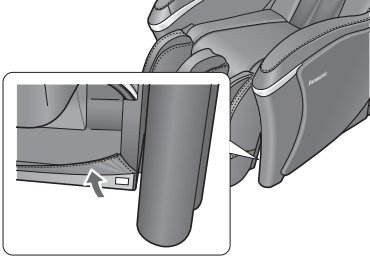
<p>Q:</p>	<p>请问哪里可以看到产品的制造编号？</p>
<p>A:</p>	<p>请抬起小腿·脚部按摩部，在座面下方的座下盒处寻找本机制造编号。</p> 

故障检修

发现故障后，首先检查并尝试以下方法。
如果在尝试后，故障依然存在，请联系服务中心。

问题
<p>► 原因和解决方法</p>
<p>电机噪声</p> <ol style="list-style-type: none"> 按摩机芯部（上半身）的操作音 <ul style="list-style-type: none"> 进行揉按或捶拍等动作时的操作音 按摩轮上移或下移时发出声音 按摩机芯大负荷工作时发出咯吱声 马达、传送带回转时发出的声音 倾斜时的操作音 小腿·脚部按摩部的操作音 气囊按摩运作音 <ul style="list-style-type: none"> 充气泵工作音 排气音 座椅下电磁阀发出的工作音 倾斜动作开始时的震动
<p>► 使用时，因本机构造而听到上述声音或有上述感觉很正常，并非故障。</p>
<p>在本机使用过程中按摩轮停止。 (响起“哔哔”声时，遥控器上的按摩手法灯熄灭，按摩停止。)</p>
<p>► 如果在使用本机时对按摩轮用力过大，出于安全考虑，按摩轮可能会停止移动。 如果按摩轮停止，关闭本机电源一次，约 10 秒钟后再次打“开”电源，然后操作本机。 如果按摩轮再次停止，请调整自己的坐姿，不要使背部完全贴在靠背上。 (体重 120 kg 或以上的人士使用本机时请注意。)</p>
<p>无法倾斜本机。 无法升高或降低小腿·脚部按摩部。 (响起“哔哔”声时，遥控器上的按摩手法灯熄灭，按摩停止。)</p>
<p>► 如果本机遇到了障碍物或者在使用本机时用力过大，出于安全考虑，本机将停止工作。 如果靠背或小腿·脚部按摩部停止，关闭本机电源一次，约 10 秒钟后再次打“开”电源，然后操作本机。</p>
<p>按摩轮没有达到肩部或颈部的位置。</p>
<p>► 肩部位置检测过程中，如果头部没有接触到靠枕，或背部没有接触到靠背，检测到的肩部位置可能低于实际位置，将头部靠在靠枕上，然后从头开始重新操作。 (参照第 C15 和 C16 页)</p>
<p>左右按摩轮的高度（强度）不同。</p>
<p>► 因为搭载了可进行按摩轮交互捶拍动作的按摩机芯，出现这种情况纯属自然。并非机体故障。 (参照第 C26 页)</p>
<p>本机根本无法运行。</p> <ul style="list-style-type: none"> 上半身（颈部至腰部）按摩 小腿和脚部按摩
<p>► 电源线连接已断开。 没有打开本机电源开关。 按 关/开 之后未按菜单选择按钮或 小腿·脚部 按钮。 (参照第 C12 页)</p>
<p>足底没有温热感。</p>
<p>► 温热 按钮被设为关。 温热感因使用者的体形、按摩动作、衣物和环境温度而异。 在腿上放置一块毯子等可以感到更加温暖。</p>
<p>即使关闭了小腿·脚部按摩的温热功能，温热部仍不冷却。</p>
<p>► 由于加热器的结构，加热后片刻依然会因为余热而感到温暖。 即使关闭了小腿·脚部按摩的温热功能，但如果对同一部位长时间按摩，您也可能会感觉特别温暖。</p>
<p>即使按下了 温热 按钮，加热器也不发热。</p>
<p>► 如果上半身按摩或小腿·脚部按摩都没有启动，温热 功能无法单独使用。 (参照第 C21 页)</p>
<p>有时候在按摩结束后再次按 关/开 按钮时，电源无法打开。</p>
<p>► 按摩结束后大约需要 5 秒钟程序才终止。当所有机器运作均已停止后至少等待 5 秒钟，然后再按 关/开。</p>
<p>本机已受损。</p>
<p>► 立即停止使用本机。</p>
<p>电源线或电源插头异常热。</p>
<p>► 立即停止使用本机。</p>

故障显示

故障显示	内容
F11 F12	内部通信出现问题，运作终止。
F04 F05 F06 F08	小腿·脚部按摩出现异常，运作终止。
F14 F33 F36 F37 F80 F81	上半身按摩轮浮动机构内部出现异常，运作终止。
F15 F16 F34 F35	倾斜装置或小腿·脚部按摩部的上下装置出现异常，按摩轮浮动机构以外的运作终止。
U10	出于安全考虑，当未能确认有人坐在按摩椅上时，按摩椅将停止运行。如果坐在按摩椅上依然出现该错误，请按下 紧急停止 ，并靠在靠背上坐好，重新进行操作。

* 请联系授权服务中心。（请在保证书上确认售后服务中心的电话号码。）
联系时若能提供故障代码，服务和维修将进行得更顺利。

- ⚠**
- 请勿擅自改造本机。请勿自行分解或修理本机。
不遵守本事项，可能引起火灾、机体运行异常或造成伤害。
 - 使用中不能动弹或发觉机体异常时，请立即停止使用，拔出电源插头，将本机送交指定维修中心检查修理。
不遵守本事项，可能引发触电或火灾。

Contents

SAFETY PRECAUTIONS	E3
GROUNDING INSTRUCTIONS	E6
SPECIFICATIONS.....	E6
PART NAMES AND FUNCTIONS	E7
SETTING UP THE UNIT	E9
BEFORE EVERY MASSAGE (CHECK THE UNIT)	E12
SELECTING A MENU AND STARTING THE MASSAGE	E14
USING “FULL BODY” PROGRAM.....	E15
USING “SELECTED AREA” MASSAGE	E18
USING “MANUAL” MASSAGE	E19
USING LEG/FOOT (HEAT/AIR) MASSAGE	E21
END THE MASSAGE.....	E23
CLEANING AND MAINTENANCE	E25
Q&A.....	E26
TROUBLESHOOTING	E29

English

SAFETY PRECAUTIONS

These must be observed

Be sure to follow these precautions to prevent injury to people or damage to property.

■ The following precautions are classified according to the extent of possible harm or damage resulting from misuse of the product.

WARNING	If not observed, may result in death or serious injury.
CAUTION	If not observed, may result in minor injury or property damage.

■ This describes the particulars of the following symbols which are to be observed. (The following are examples of the symbols)



Do not do particulars.	Particulars which must be implemented.
------------------------	--

! WARNING

English

	Be sure to observe	<ul style="list-style-type: none"> • Persons in any of the conditions listed below or who are undergoing medical treatment should consult with their physician before using the unit: <table style="width: 100%; border: none;"> <tr> <td style="width: 50%; vertical-align: top;"> <ul style="list-style-type: none"> (1) People using an implanted medical electronic device such as a pacemaker, prone to electromagnetic interference (2) People who have a malignant tumor (3) People with a heart disease (4) People who are recognized as having temperature sensory loss (5) Women who are pregnant or who recently gave birth (6) People with sensory disturbance due to advanced peripheral circulatory failure caused by diabetes, etc. (7) People with osteoporosis, spinal fracture or disorder with acute pain such as sprains and torn muscles (8) People who have wounds on treated parts </td> <td style="width: 50%; vertical-align: top;"> <ul style="list-style-type: none"> (9) People with a body temperature above 38°C (fever) (Example: Periods when acute inflammatory disorders [fatigue, chills, blood pressure fluctuation, etc.] are severe, when the body is weak) (10) People who need to rest, and people who are not feeling well at all (11) People with an abnormality or irregular curvatures of the spine (12) People with spinal disc herniation (13) People who feel a physical abnormality other than the above </td> </tr> </table> <p>Failure to observe this may result in accident or physical disorder.</p> • If you notice or feel any physical abnormality or do not notice any results after use, stop using the unit immediately and consult with a physician. Failure to observe this may result in accident or physical disorder. • While using the massage or when adjusting the backrest or leg/foot massage section, make sure there are no people or pets around the unit (behind, underneath, in front or side of the unit). Failure to observe this may result in accident or injury. • Before using the unit, always raise the pillow and lower back cover to check that there are no rips in the fabric covering the area where the massage heads move. (No matter how small the rip, stop using the unit immediately, unplug the power cord, and have the unit repaired.) Using the unit with a ripped fabric may result in injury or electric shock. • Be sure to start on the gentle massage program “舒展放松(RELAX)” when using the unit for the first time. • The unit must not be used for more than a total of 15 minutes. • Avoid massaging any one part of your body for more than 5 minutes at a time. Failure to observe this may result in an adverse effect or injury. • After use, be sure to slide the power switch to the “off” position and turn the lock switch to the “lock” position, and remove the key and power plug. Failure to observe this may result in accident or injury due to tampering by children. • Store the lock switch key out of the reach of children. Failure to observe this may result in accidental swallowing, or accident or injury due to tampering. • Do not exceed the ratings of electrical outlets and wiring devices. • Use AC 220V. (The unit cannot be used overseas or with a transformer.) Failure to observe this may cause electric shock, malfunction or fire due to overheating. • Be sure to push the power plug all the way in. Failure to observe this may cause electric shock or fire due to overheating. • Regularly wipe any dust off the power plug. Failure to observe this may lead to insulation failure due to humidity, etc. and cause fire. (Wipe off dust with a dry cloth.) 	<ul style="list-style-type: none"> (1) People using an implanted medical electronic device such as a pacemaker, prone to electromagnetic interference (2) People who have a malignant tumor (3) People with a heart disease (4) People who are recognized as having temperature sensory loss (5) Women who are pregnant or who recently gave birth (6) People with sensory disturbance due to advanced peripheral circulatory failure caused by diabetes, etc. (7) People with osteoporosis, spinal fracture or disorder with acute pain such as sprains and torn muscles (8) People who have wounds on treated parts 	<ul style="list-style-type: none"> (9) People with a body temperature above 38°C (fever) (Example: Periods when acute inflammatory disorders [fatigue, chills, blood pressure fluctuation, etc.] are severe, when the body is weak) (10) People who need to rest, and people who are not feeling well at all (11) People with an abnormality or irregular curvatures of the spine (12) People with spinal disc herniation (13) People who feel a physical abnormality other than the above
<ul style="list-style-type: none"> (1) People using an implanted medical electronic device such as a pacemaker, prone to electromagnetic interference (2) People who have a malignant tumor (3) People with a heart disease (4) People who are recognized as having temperature sensory loss (5) Women who are pregnant or who recently gave birth (6) People with sensory disturbance due to advanced peripheral circulatory failure caused by diabetes, etc. (7) People with osteoporosis, spinal fracture or disorder with acute pain such as sprains and torn muscles (8) People who have wounds on treated parts 	<ul style="list-style-type: none"> (9) People with a body temperature above 38°C (fever) (Example: Periods when acute inflammatory disorders [fatigue, chills, blood pressure fluctuation, etc.] are severe, when the body is weak) (10) People who need to rest, and people who are not feeling well at all (11) People with an abnormality or irregular curvatures of the spine (12) People with spinal disc herniation (13) People who feel a physical abnormality other than the above 			

WARNING

 Forbidden	<ul style="list-style-type: none"> The following persons should not use the unit. People who are prohibited from receiving massage by a physician (Example: people with thrombosis or embolism, serious aneurism, acute varicose veins, any type of dermatitis or skin infection [including hypodermic infection], etc.) Failure to observe this may worsen the symptoms.
	<ul style="list-style-type: none"> Do not let children use the unit. Also, do not let children play on the unit or climb onto the leg/foot massage section, seat, backrest or armrest. Do not climb onto the backrest or armrest. This unit must not be used by people who cannot express their will or operate the unit. Pay attention to the movement of the massage heads when massaging the neck area, and do not massage the front of the neck and avoid excessively strong massages. Doing so may result in accident or injury.
	<ul style="list-style-type: none"> Do not damage the power cord or the power plug. (Do not damage it, modify it, place it near a thermal device, bend it by force, twist it, pull it, place a heavy object on it or bundle it.) If they are used in a damaged condition, it may cause electric shock, short circuit or fire. If the power cord or power plug needs to be repaired, contact your dealer or the Customer Service Center.
	<ul style="list-style-type: none"> Do not use the sole heat massage for a long time. Low-temperature burn* may occur. *Despite comparatively low temperature (40°C – 60°C), when the heater section has touched the same area of the skin for a long time, a low-temperature burn may occur even though you do not notice any sensations such as heat or pain etc.
	<ul style="list-style-type: none"> Do not damage the heater section. (See page E7.) <ul style="list-style-type: none"> Do not stick the main unit with a pin or needle. Do not damage it with a blade. Failure to observe this precaution may cause a damage to the internal heater, and result in a fire or electric shock.
 Wet hands forbidden	<ul style="list-style-type: none"> Do not insert or pull out the power plug with wet hands. Doing so may cause electric shock.
 Disassembly forbidden	<ul style="list-style-type: none"> Never attempt to remodel the unit. Also, do not attempt to disassemble or repair the unit yourself. Doing so may result in fire, abnormal operation or injury.

CAUTION

 Be sure to observe	<ul style="list-style-type: none"> The following persons must consult with a physician before use, even if they are currently healthy. (1) People with weak muscles due to aging or slim people, (2) People with lumbago attributed to bones or internal organs, (3) People who often bruise or sustain sprains, (4) People who suffer from severe motion sickness, (5) People who have had a heart surgery or surgery of the internal organs in the past. Failure to observe this may result in impairing your health.
	<ul style="list-style-type: none"> Sit on the unit after confirming there is no foreign matter between the parts of the unit. (Check that there is no foreign matter stuck in the backrest, seat, leg/foot massage section or the rear of the pillow and the lower back cover.) Failure to observe this may cause an accident, injury or malfunction due to your hands, feet or matter getting caught.
	<ul style="list-style-type: none"> Sit on the unit after removing any hard items such as hair accessories worn on the head. Failure to observe this may result in injury.
	<ul style="list-style-type: none"> Sit on the unit after checking that the massage heads are in the retracted position. When getting off the unit during a massage program, always turn off the operation before getting off. Failure to observe this may result in accident or injury.
	<ul style="list-style-type: none"> When unplugging the unit, always hold the power plug and not the power cord. Failure to observe this may result in electric shock or short circuit.
	<ul style="list-style-type: none"> To ensure safety, connect the unit to a properly grounded outlet. Failure to observe this may result in electric shock in case of a malfunction or ground leakage.
	<ul style="list-style-type: none"> When moving the unit, make sure to return the leg/foot massage section to its initial position. Failure to observe this may result in injury.
	<ul style="list-style-type: none"> When using the wheels to move the unit, remove any obstacles around the unit, return the backrest to its original position, lift the leg/foot massage section and seat no higher than the waist, and move it slowly. (See page E10.) Failure to observe this may result in accident or injury due to the unit falling down.

⚠ CAUTION



Be sure to observe

- Use the unit on the flat area.
Failure to observe this precaution may result in accidents or injuries due to the unit fallen down.
- If the unit does not work or if an abnormality is felt, stop using it immediately, unplug the unit and request an inspection/repair.
Failure to observe this may result in electric shock or fire.
- If you notice symptoms such as rash, reddening of the skin or itching due to the use of the unit, stop using it and consult with a physician.
Failure to observe this may result in accident or physical disorder.
- If the unit has not been used for some time, carefully read the instruction manual again, and check that the unit functions properly before use.
Failure to observe this may result in accident or injury.
- When moving the unit with the wheels, place a mat etc. on the floor.
Failure to observe this may cause damage to the floor.



Forbidden

- Do not use the unit together with other therapy apparatus.
Doing so may result in accident or physical disorder.
- Do not allow children to use the controller holder clamp screw.
Failure to observe this may result in accidental swallowing, or accident or injury due to tampering.
- Do not apply the massage heads on the head, stomach or bare skin. Also, do not put your hand or leg between the massage heads.
- Do not put your knees between the calf or sole massage section.
- Do not fall asleep while using the unit or use the unit after drinking alcohol.
Doing so may result in accident or injury.
- Do not insert your hand or foot between the unit and the leg/foot massage section.
- Do not unplug the unit or turn off the power switch during a massage program.
Failure to observe this precaution may result in injury.
- Do not stand on the leg/foot massage section when it is not completely retracted.
The unit may tilt and result in accident or injury.
If the base of the leg/foot massage section touches the floor, the floor may be damaged.
- Do not insert your hand, arm, head etc. in the gap between the leg/foot massage section.
To be safe, be sure to lower the leg/foot massage section and slide it back into place after finishing a massage.
Failure to observe this precaution may result in injury.
- Do not drag or push the unit in an installed state.
The floor may be damaged.
- Do not move the unit with a person sitting on it.
Failure to observe this precaution may result in accidents or injuries due to the unit fallen down,
- When moving the unit, do not hold it by anything else except for the plastic part on the leg/foot massage section. (See page E10.)
The section may slide during the move and result in injury.
- The unit should not be used on top of heating appliances, such as electric carpets, etc.
Doing so may result in fire.



Use in wet places forbidden

- The unit should not be used in bathrooms or other damp or humid places
This may cause electric shock or the unit to malfunction.



Exposure to water forbidden

- Water, etc. should not be spilled on the unit and controller.
Failure to observe this may cause electric shock, short circuit or malfunction.



Unplug the power cord

- Unplug the power plug from the outlet when cleaning the unit.
Failure to observe this may result in electric shock or injury.
- In case of a power failure, unplug the power plug immediately.
Failure to observe this may result in accident or injury when power is resumed.
- Unplug the power plug from the outlet when not in use.
Failure to observe this may lead to insulation failure due to dust and humidity, and cause fire due to electric leakage.

GROUNDING INSTRUCTIONS

The unit must be properly grounded. If it should malfunction or break down, grounding provides a path of least resistance for electric current in order to reduce the risk of electric shock.

This unit is equipped with a cord with an equipment-grounding conductor and a grounding plug. The plug must be plugged into an appropriate outlet that has been properly installed in accordance with all local codes and ordinances.

CAUTION

Improper connection of the equipment-grounding conductor may lead to electric shock. Check with a qualified electrician if you are in doubt as to whether or not the unit is properly grounded. Do not modify the plug provided with the unit if it will not fit the power outlet. Instead, have a proper outlet installed by a qualified electrician.

This unit has a grounding plug. Make sure that the product is connected to a power outlet with the same configuration as the plug. Do not use an adaptor with this unit.

SPECIFICATIONS

Power Supply:	AC 220 V 50 Hz
Power Consumption:	139 W
Upper Body Massage:	
Massage area (Up-Down):	Approx. 64 cm (The massage heads move a total of approx. 58 cm)
Massage area (Left-Right):	Distance between massage heads during operation Neck, Shoulder, Back, Lower back: Approx. 4 cm – 15 cm
Massage area (Forward-Back):	Projected amount of massage head Approx. 6 cm
Massage speed:	Tap : Approx. 285 min ⁻¹ – 495 min ⁻¹ (single side) Knead: Approx. 7 min ⁻¹ – 25 min ⁻¹ Movement speed: Approx. 2 cm/s – 4.5 cm/s
Massage width:	Same as massage area (left-right)
Air Massage:	
Air Pressure:	3: Approx. 32 kPa 2: Approx. 28 kPa 1: Approx. 20 kPa
Automatic Shut-off:	Automatically turns off after a maximum of 15 minutes
Dimensions (H x W x D):	
When not reclined:	Approx. 105 cm x 78 cm x 150 cm
When reclined:	Approx. 82 cm x 78 cm x 176 cm
Weight of Unit:	Approx. 63 kg
Dimensions of Box (HxWxD):	Approx. 83 cm x 86 cm x 179 cm
Weight in Box:	Approx. 82 kg
Maximum User Weight:	Approx. 120 kg
Applicable standard	GB4706.1 GB4706.10

English

For those who weigh 100 kg or more, the product operations may make more noise and the fabric cover may wear faster.

Dimensional drawing

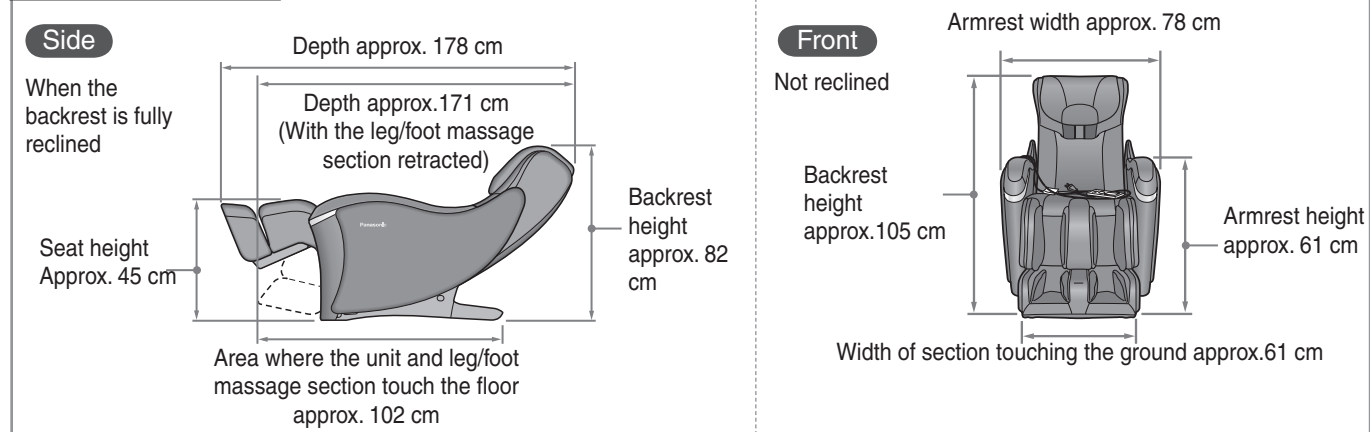

PART NAMES AND FUNCTIONS

Main unit

Front

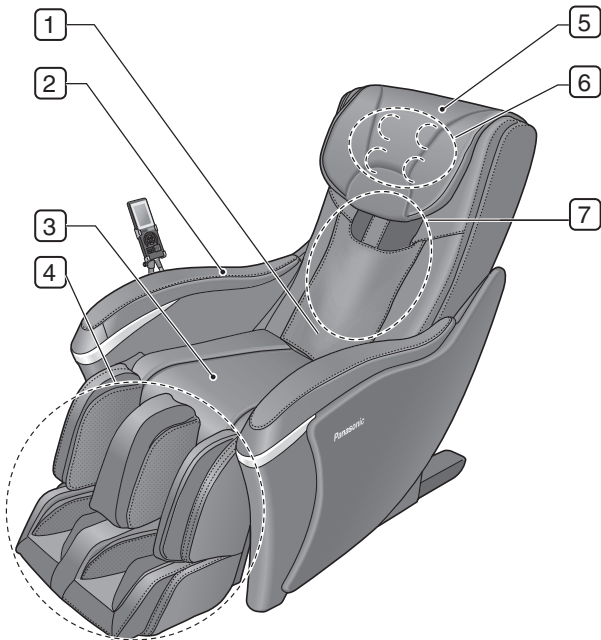

Back

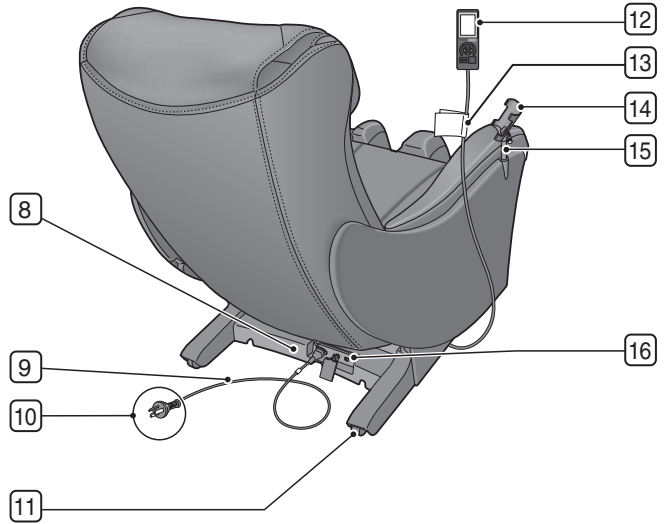

English

- 1 Lower Back Cover
- 2 Armrest
- 3 Seat
- 4 Leg/Foot Massage Section

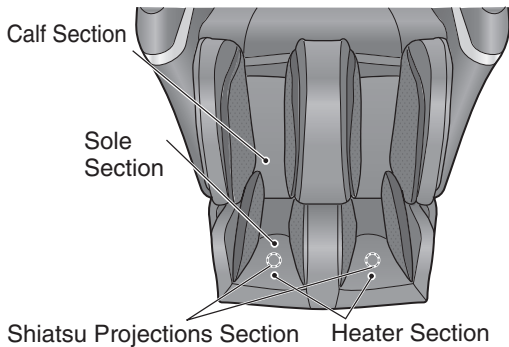

- 5 Pillow
- 6 Retracted Position of Massage Heads
- 7 Backrest

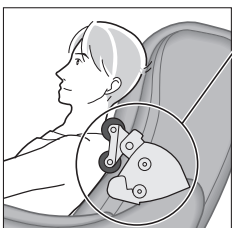

Massage Heads = embedded massage function with kneading float mechanism

- 8 Specification Label
- 9 Power Cord
 - Cord length: approx. 1.8 m
- 10 Power Plug

- 11 Wheels
- 12 Controller
- 13 Safety Precaution Label
- 14 Controller Holder

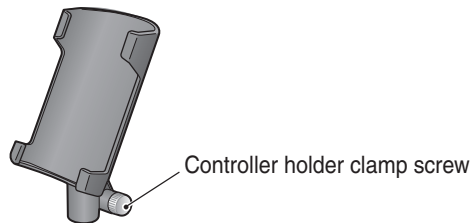

- 15 Controller Stand
- 16 Power Switch Section

- See page E12.
- Lock switch is set to “open” and power switch is set to “on” prior to leaving the factory.

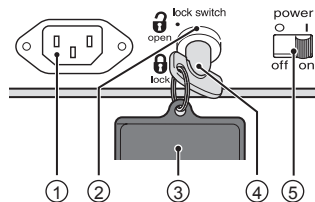

- 1 Appliance Inlet
- 2 Lock Switch
- 3 Lock Switch Key Tag
 - To prevent children from accidentally swallowing the lock switch key.
- 4 Lock Switch Key
- 5 Power Switch

Controller

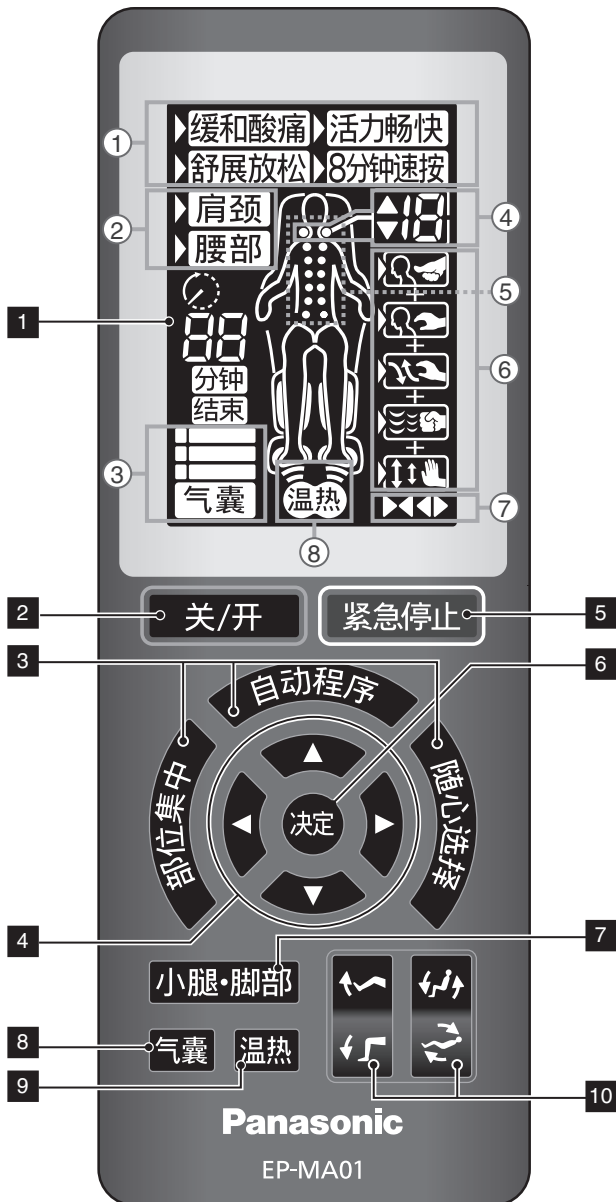

Display

- ① **“FULL BODY” Program Display**
 - When selecting a program: The ► mark for the currently selected program is displayed.
 - During the massage: The current program is displayed.
- ② **“SELECTED AREA” Program Display**
 - When selecting a program: The ► mark for the currently selected program is displayed.
 - During the massage: The current program is displayed.
- ③ **Leg/Foot Air Massage Intensity Display**
 - Displays intensity of current leg/foot massage in 3 levels.
- ④ **Shoulder Position Display**
 - Flashes in shoulder position adjustment mode (approx. 15 seconds)
 - Lights up while the "FULL BODY" and "SELECTED AREA" programs are operating to display the shoulder positions.
- ⑤ **Massage Head Position Display**
 - Displays current approximate position of massage heads.
- ⑥ **Massage Operation Display** (See page E19.)
- ⑦ **Width Display**
 - When using the operation in which the width can be adjusted in the 随心选择 mode, displays the current spans during massages.
 - ◀ Narrow width / ▶ Widen width
- ⑧ **Heat Operation Display**
 - Displays the on/off status of the sole warmth.
 - If the set temperature is exceeded, the double line on the warmth operation screen will switch from flashing to being steadily lit.

1 Display

- This illustration is when all lamps are illuminated.

2 Off/On button

- Switches the controller on and off.

3 Menu Selection buttons

- #### 4 Up/Down (▲ / ▼)- Adjustment buttons Left/Right (◀ / ▶)- Adjustment buttons

5 Quick Stop button

- Press this button to stop the massage immediately.

6 O.K. button

7 Leg/foot Massage Off/On button

- Switches the leg/foot massage on and off.

(See page E21.)

8 Leg/foot Air Intensity buttons

9 Sole Heat Off/On button

10 Reclining Angle Adjustment button

- Leg/foot Massage Section Angle Adjustment button

SETTING UP THE UNIT

TO START WITH (INSTALLATION LOCATION)

Before taking the unit out of the box, decide where it is going to be set up. Ensure that there is enough space for the unit power switch to be operated. (Approx. 10 cm of space in both the rear and on both sides)

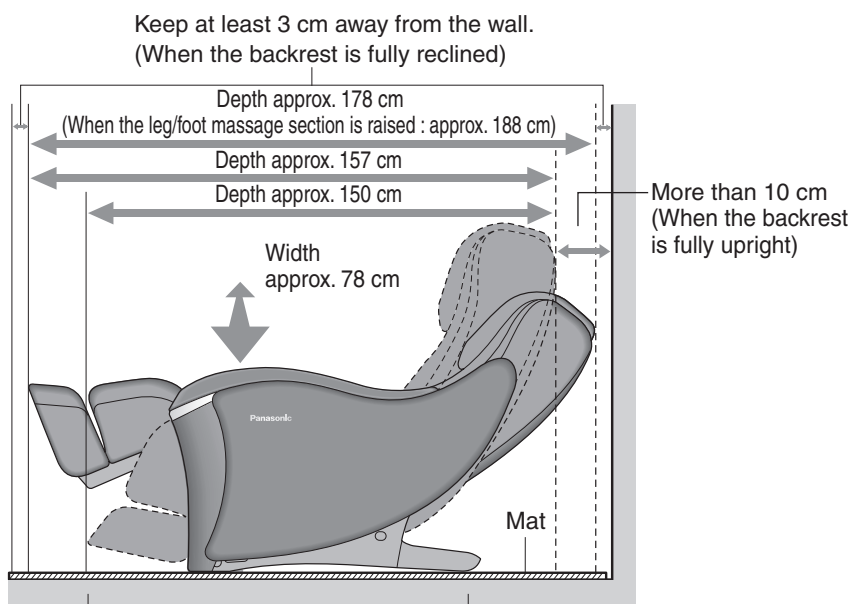

- The unit should not be used in bathrooms or other damp or humid places. This may cause electric shock or the unit to malfunction.
- Use the unit on the flat area. Failure to observe this precaution may result in accidents or injuries due to the unit fallen down.
- The unit should not be used on top of heating appliances, such as electric carpets, etc. Do not operate the unit under blanket or pillow. Excessive heating can occur and cause fire, electric shock, or injury to persons.

English

- Do not expose the massage lounger to direct sunlight or high temperatures, such as in front of heating sources, because this can cause discoloration or hardening of the synthetic leather.
- Make sure to install the unit so that the back side of the main unit does not touch the wall or any objects. (Failure to do so may cause damage such as the back side deformation.)
- Place the unit on a mat to prevent floor damage. When placing a mat under the unit, the size of the mat should be sufficient (at least 63 cm x 104 cm) to cover the areas where the unit touches and where the leg/foot massage section could touch the floor, as shown in the diagram.
- Install the unit near a power outlet.

1. Open the packaging and take out the unit and accessories.

Confirm that the main unit and the accessories are in the box.

Main unit

*Illustrated in the condition that it is taken out of the box.

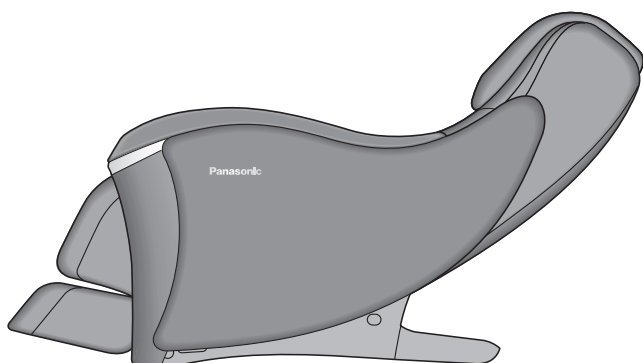

(When the backrest is fully reclined)

Accessories

Controller Holder

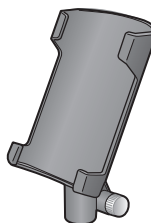

Power Cord

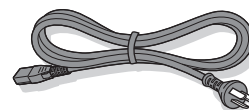

Lock Switch Key 1 pcs.



- The lock switch key has been inserted in the lock switch prior to leaving the factory.

2. Moving the unit and setting it up.

- Since the unit is very heavy (approximately 63 kg), be careful to avoid back injuries. (The unit must be carried by two persons.)
- Put the unit down slowly and carefully watch your step.

- ⚠
- Do not drag or push the unit in an installed state. The floor may be damaged.
 - Do not move the unit with a person sitting on it. Failure to observe this precaution may result in accidents or injuries due to the unit fallen down.

Lifting the unit to install and setup the unit

- You may damage the floor by dropping the unit if you do not hold it correctly.

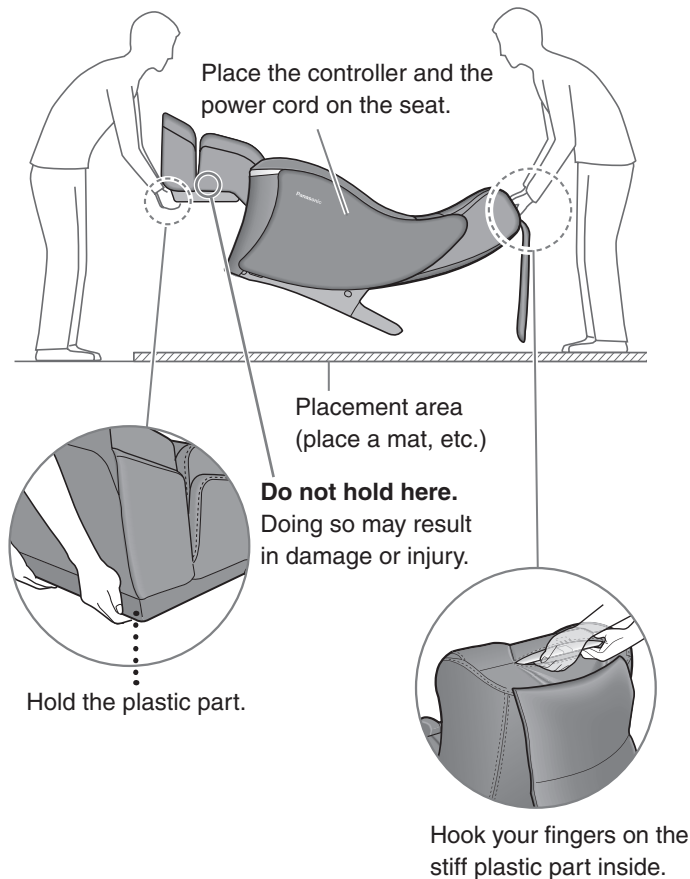

Install the unit with the backrest away from the wall.

Make sure the backrest does not touch the wall.

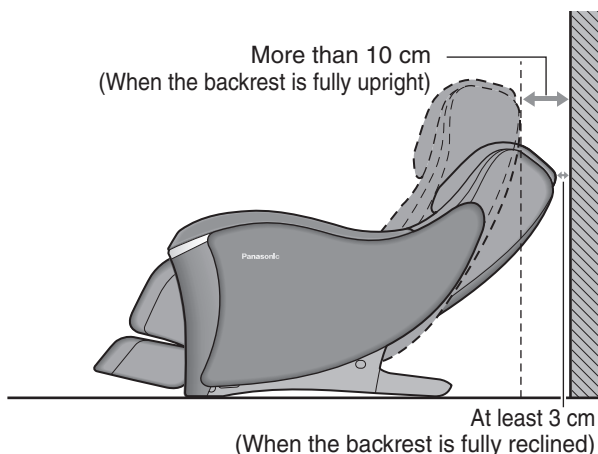

Using the wheels to move the unit

- ⚠
- When moving the unit with the wheels, place a mat etc. on the floor. Failure to observe this may cause damage to the floor.

After procedures 1 to 5 on page E12;

- 1) Press the  button to return

the back rest to its original position.

- 2) Slide the power switch to the “off” position and unplug the unit.

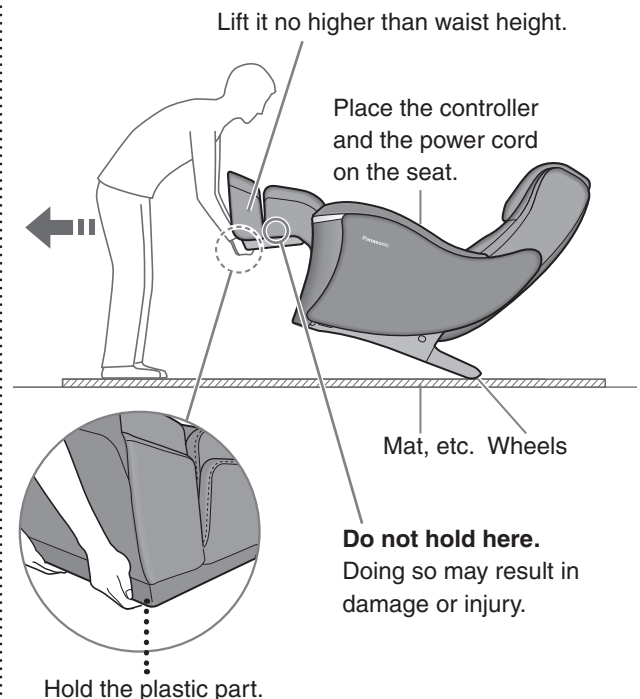

Connect the power cord to the unit

- 1) Check for dirt and damage on appliance inlet of the power switch section and the connector of the power cord.
- 2) Insert the connector into the appliance inlet.
- 3) Be sure to push the connector in all the way.

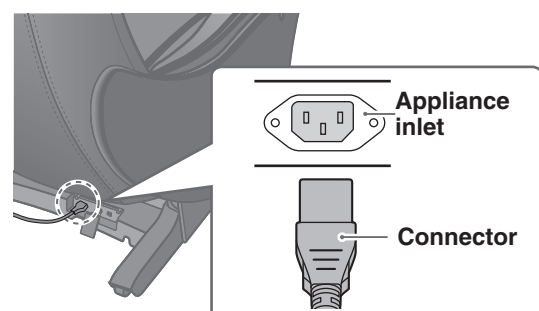

3. Assembly

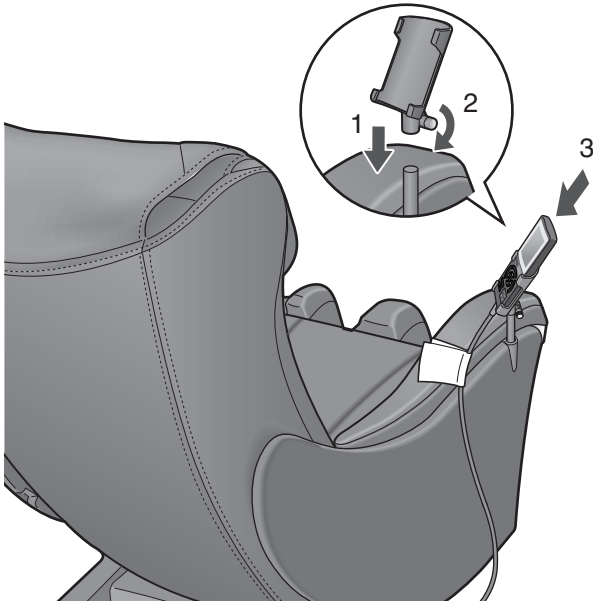

Attach the controller holder and place the controller into the controller stand.

- 1** Insert the controller holder into the controller holder until it clicks in to place.
- 2** Fasten the controller stand with the controller holder clamp screws.
- 3** Placing the controller into the controller stand.

- ⚠ • Do not allow children to use the controller holder clamp screw. Failure to observe this may result in accidental swallowing, or accident or injury due to tampering.

BEFORE EVERY MASSAGE (CHECK THE UNIT)

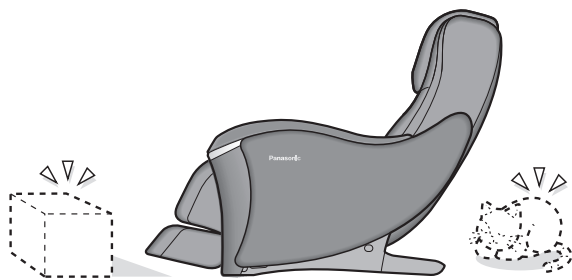

1 Check the surrounding area.

Make sure there are no objects, people, or pets in the vicinity of the unit.



2 Flip up the pillow.

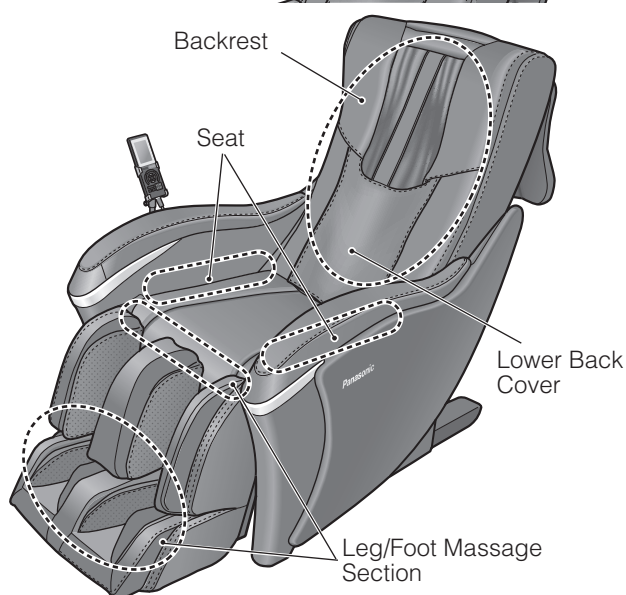

3 Make sure there is no foreign matter between the unit.

- ⚠️ Sit on the unit after confirming there is no foreign matter between the parts of the unit. (Check that there is no foreign matter stuck in the backrest, seat, leg/foot massage section or the rear of the pillow and the lower back cover.)

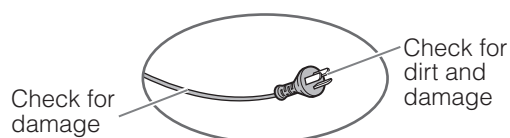

4 Check the power cord and the power plug.

- ⚠️ Regularly wipe any dust off the power plug. Failure to observe this may lead to insulation failure due to humidity, etc. and cause fire. (Wipe off dust with a dry cloth.)
 - Do not damage the power cord or the power plug. (Do not damage it, modify it, place it near a thermal device, bend it by force, twist it, pull it, place a heavy object on it or bundle it.)
- If they are used in a damaged condition, it may cause electric shock, short circuit or fire. If the power cord or power plug needs to be repaired, contact your dealer or the Customer Service Center.

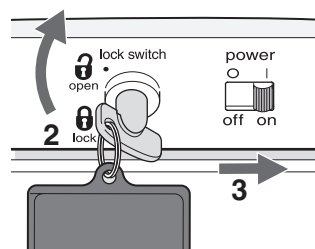
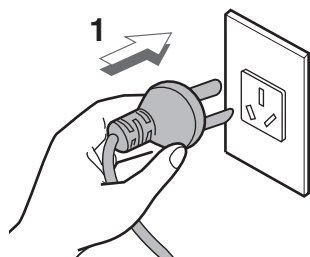

5 Switch on the power supply.

- ⚠️ Be sure to push the power plug all the way in. Failure to observe this may cause electric shock or fire due to overheating.
- Do not exceed the ratings of electrical outlets and wiring devices.
- Use AC 220V. (The unit cannot be used overseas or with a transformer.)
- Failure to observe this may cause electric shock, malfunction or fire due to overheating.
- Do not insert or pull out the power plug with wet hands. Doing so may cause electric shock.

1 Insert the power plug into an electrical outlet.

2 Turn the lock switch key to the "open" position.

3 Slide the power switch to the "on" position.

* When the electrical plug is plugged in and the power is switched "On," the controller display might momentarily light up.

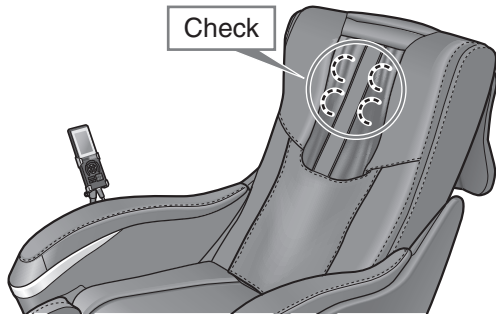

6 Touch the massage heads with your hands to make sure that they are retracted.

- ⚠ • Sit on the unit after checking that the massage heads are in the retracted position. Failure to observe this may result in accident or injury.

When the massage heads are not in the retracted position

- Press the **关/开** button twice to return the massage heads to the retracted position.

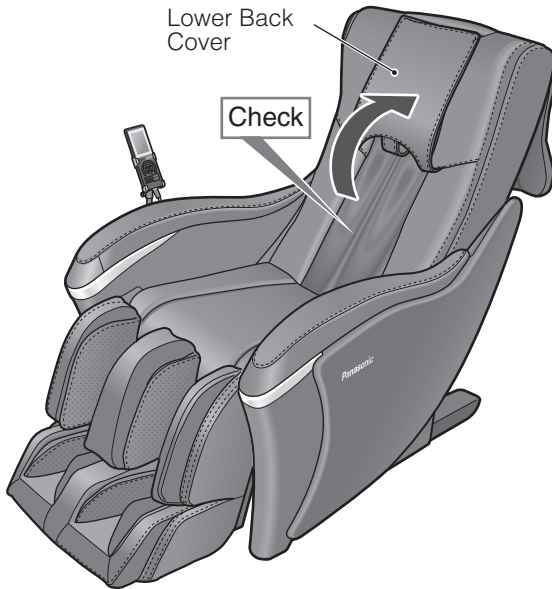

7 Check that the fabric of the unit where the massage heads move has not been ripped.

- Flip the pillow and lower back cover to check the fabric where the massage heads are moveable.

- ⚠ • Before using the unit, always raise the pillow and lower back cover to check that there are no rips in the fabric covering the area where the massage heads move. (No matter how small the rip, stop using the unit immediately, unplug the power cord, and have the unit repaired.) Using the unit with a ripped fabric may result in injury or electric shock.

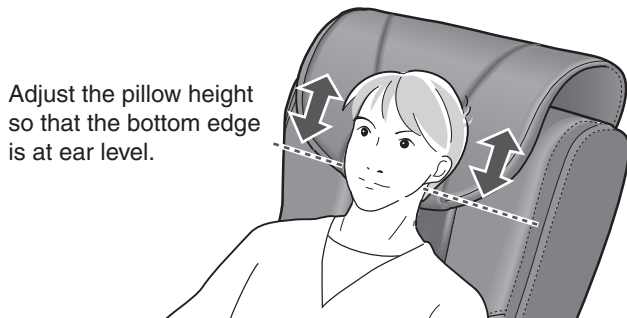

8 Sit down and adjust the pillow.

Adjust the controller stand.

- Adjustable to the right and the left.

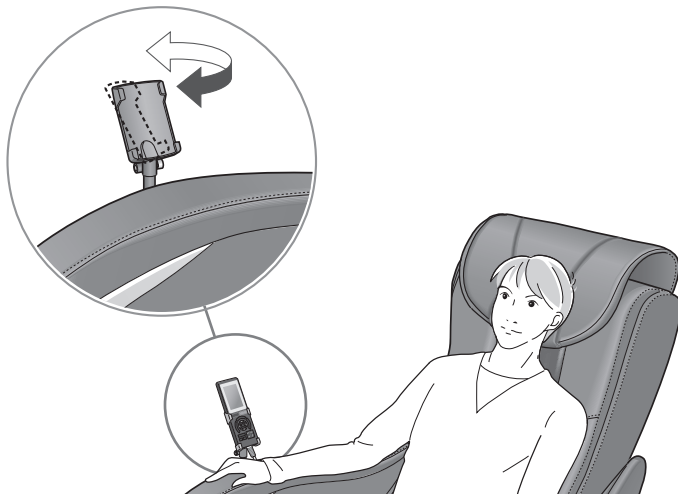

9 Select a massage menu.

(See page E14.)

10 Adjust the reclining angle as necessary.

SELECTING A MENU AND STARTING THE MASSAGE

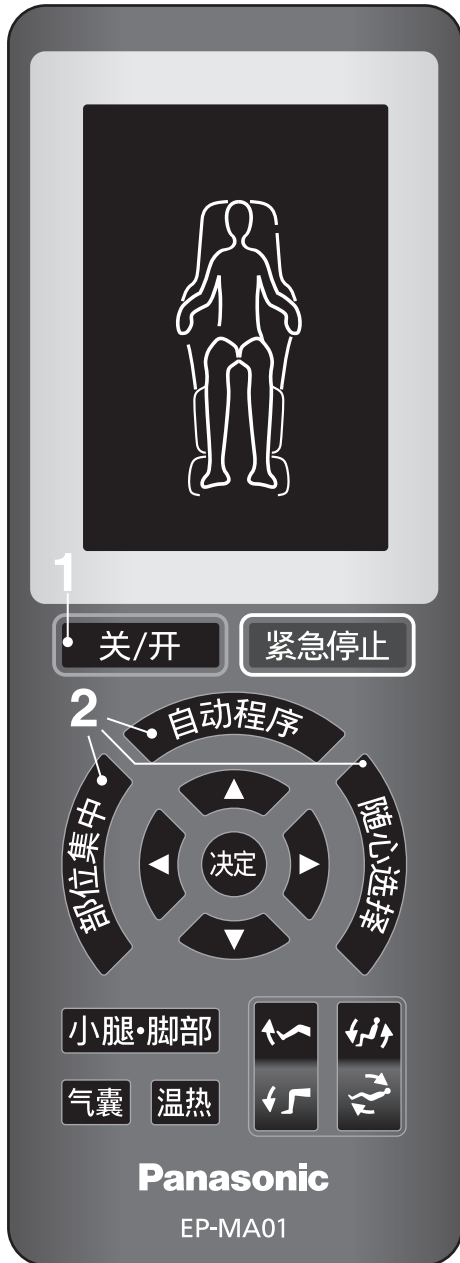

- ⚠ • Be sure to start on the gentle massage program “舒展放松(RELAX)” when using the unit for the first time.
 - The unit must not be used for more than a total of 15 minutes.
 - Avoid massaging any one part of your body for more than 5 minutes at a time.
- Failure to observe this may result in an adverse effect or injury.
- After 15 minutes of use, we recommend that you take a 10 minute break.
 - Use the unit up to twice per day, for a total of 30 minutes.

1 Press the **关/开** button to turn on the power.

(The power will turn off automatically if you do not select a menu or start a leg/foot massage within 3 minutes after turning on the power.)

2 Select a menu from among “FULL BODY”, “SELECTED AREA” and “MANUAL” operation.



FULL BODY Program (See page E15.)

You can select from among 4 programs for automatically loosening from neck to lower back.

- The leg/foot (heat/air) massage begins simultaneously.



SELECTED AREA Program (See page E18.)

You can select “肩颈 (NECK SHOULDER)” or “腰部 (LOWER BACK)”.

- The leg/foot massage begins simultaneously.



MANUAL (See page E19.)

You can concentrate the massage on desired areas.

When using the Leg/foot (Heat/Air) massage only

To start the Leg/foot massage

Press the **小腿·脚部** button. (See step 2 on page E21.)

If the power of the main unit is turned off or if the power plug is removed, the massage heads may automatically move when being used next time.

When the massage heads are moving, the following display appears. This is not a malfunction. The unit can be used as normal after the massage heads move for a while.

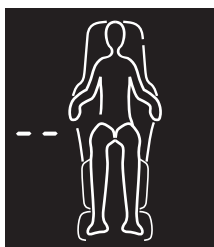

USING "FULL BODY" PROGRAM

[Program Selection Mode]



English

Press the **自动程序** button to enter the program selection mode for FULL BODY Programs.
(The power will turn off automatically if no operation is performed within 3 minutes after entering the program selection mode.)

1 Press ▲▼◀▶ to select a program.

Select one of “缓和酸痛 (DEEP)”, “舒展放松 (RELAX)”, “活力畅快 (REFRESH)” and “8分钟速按 (QUICK (8 min.))”.



A flashing arrow indicates the currently selected program.

The leg/foot massage start simultaneously no matter which programs are selected.

“FULL BODY” Program characteristics

缓和酸痛 (DEEP)

When you want to have a firm deep tissue massage for neck and shoulder stiffness, lower back fatigue and your entire body, the massager will knead your neck and shoulder area upwards and downwards, and roll your entire body.

活力畅快 (REFRESH)

When you want to have a rhythmical massage for neck, shoulder and lower back stiffness, the massager will focus on tapping to the entire body. This massage program invigorates and refreshes.

舒展放松 (RELAX)

When you want to have a gentle tension-releasing massage for neck and shoulder stiffness, and full body fatigue, the massager will focus on kneading and stretching the back muscles to gently relax the entire body.

8分钟速按 (QUICK (8 min.))

When you want to have a quick tension-releasing massage in your short break, based on the “缓和酸痛 (DEEP)” program, the massager will concentrate on kneading and loosening the points where stiffness and fatigue are easily felt in an abbreviated 8-minute program.

2 Select a program and press the **决定** button.

1 The unit will automatically recline to the correct massage position.

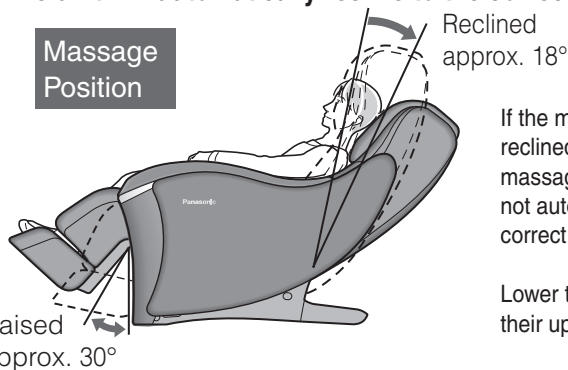

If the massage lounger is reclined further than the massage position angle, it will not automatically return to the correct massage position.

Lower the massage heads from their upper retracted position.

2 Put your head and shoulders on the backrest.



The massage heads will move slowly upwards with the unit emitting a beeping sound.

3 The massage heads rise up and stop where they least contact the body.

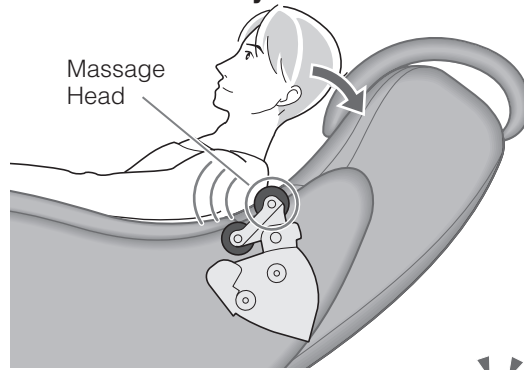

4 A double beep and the flashing of  indicate that the massage heads are being finely adjusted to the shoulder position.

[Shoulder Position Adjustment Mode]



<How to adjust>



Press ▲ ▼ to adjust the position.
(Each press moves the massage heads approximately 1.5 cm.)

5 When the shoulder position is matched, press  to begin the program.

- The program will begin automatically in 15 seconds if the  button is not pressed.

Notes

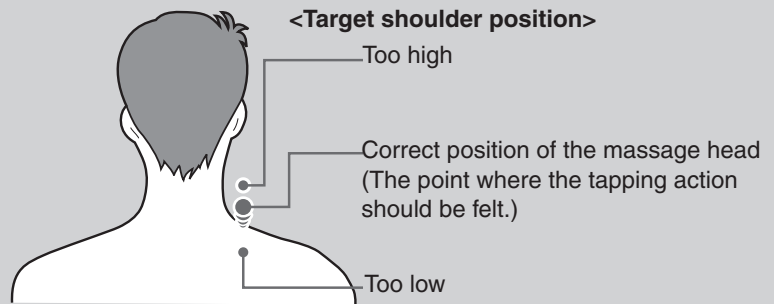

- After the shoulder position has been fixed, the Leg/foot massage section may raise up based on the height for a person short in height. (To make sure that the feet can reach the sole section when simultaneously using the leg/foot massage.)
- The shoulder position can be adjusted whenever the massage is operating. When using “随心选择 (MANUAL)”, it can not be adjusted.

Be sure to put your head and shoulders on the backrest then start the massage.

- Do not move your head and shoulders away from the backrest until the shoulder position is determined. If the shoulder confirmation does not work well, an error will display (U10), and the operation might end. (See page E30.)



To Customize

- When turning off the the Leg/foot (Heat/Air) massage

Press the **小腿·脚部** button.

(See page E21.)

- To adjust the intensity of the Leg/foot (Air) massage

Press the **气囊** button.

(See page E21.)

- When turning off the sole heat function only.

Press the **温热** button.

(See page E21.)

To change the content of the massage

- To select a different program from “FULL BODY” massage

Press the **自动程序** button, and select a different program.
Upper body massage will stop temporarily.

(See page E15.)

- To change to “SELECTED AREA” massage

Press the **部位集中** button and select a program.
Upper body massage will stop temporarily.

(See page E18.)

- To change to Manual operation

Press the **随心选择** button.
Upper body massage and foot operation will stop temporarily.

(See page E19.)

Display during program

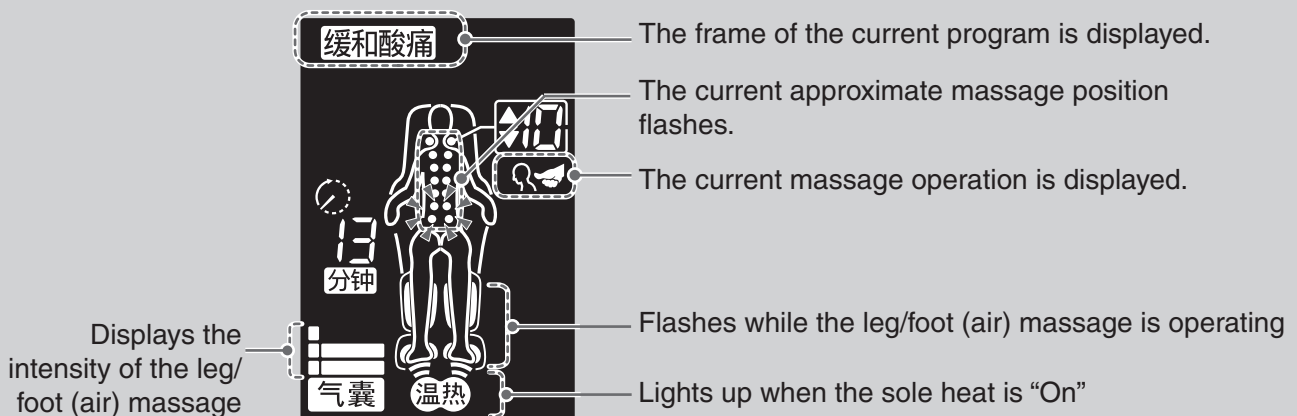

USING “SELECTED AREA” MASSAGE

[Program Selection Mode]



Press the **部位集中** button to enter the program selection mode for **SELECTED AREA**.

(The power will turn off automatically if no operation is performed within 3 minutes after entering the program selection mode.)

1 Press the ▲▼ buttons to select a program.

Select either “肩颈 (NECK SHOULDER)” or “腰部 (LOWER BACK)”.



A flashing arrow indicates the currently selected program.

The leg/foot massage start simultaneously no matter which programs are selected.

2 Select a program and press the **决定** button.

The unit will automatically recline to the correct massage position.

(See page E15.)

To Customize

- When turning off the leg/foot(heat/air) massage
Press the **小腿·脚部** button.
- To adjust the intensity of the leg/foot (air) massage
Press the **气囊** button.
- When turning off the heat function only.
Press the **温热** button.

(See page E21.)

To change the content of the massage

- To select a different program from “SELECTED AREA”

Press the **部位集中** button and select a program.
Upper body massage will stop temporarily.

- To change to “FULL BODY” massage

Press the **自动程序** button, and select a different program.

Upper body massage will stop temporarily.

(See page E15.)

- To change to “MANUAL” operation

Press the **随心选择** button.

Upper body massage and the leg/foot massage will stop temporarily.

(See page E19.)

USING "MANUAL" MESSAGE

⚠ • Avoid massaging any one part of your body for more than 5 minutes at a time.
Failure to observe this may result in an adverse effect or injury.

Press the **随心选择** button to select preferred message operating mode.
(The power will turn off automatically if no operation is performed within 3 minutes.)

Basic message (when used with a single operation)

1 Select the types of massage using the ▲▼ buttons.

Select the types of massage from Neck roll, Neck knead, Knead, Tap and Back roll.

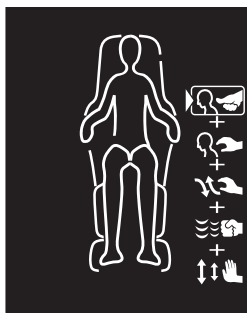
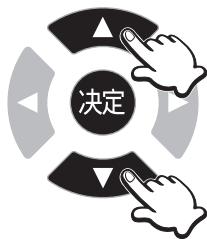

*The selected type ► flashes.

<Types of massage>

	Type	Operation
1	Neck roll	Neck roll
2	Neck knead	Neck knead
3	Knead	Knead downwards
		Knead upwards
4	Tap	Normal
		Soft
5	Back roll	Full
		Partial

2 Press ◀▶ buttons when selecting a massage operation.



*The chosen operation is encircled by a frame.

3 Press the 決定 button.

The massaging position is automatically set.
The message starts with the selected operation.
If "Neck roll," "Neck knead," or "Back roll" are selected, the operation starts by the approximate location of the shoulders being checked.

(Foot massaging does not simultaneously start)
(See page E15.)

<Note>

If the 決定 button is pressed without an operation being selected, the same operation will be selected that was operated when the ▶ button was pressed once.

When choosing an operation, the selection sequence can be reversed by pressing ◀ button.

When using a combination of several massage operations

(Example) When selecting "Knead (Upwards)", "Tap (Normal)" and "Back roll (Partial)"

1. Use the ▲▼ buttons to select the type of "knead" massage.



2. Select "Knead upwards" with ▶ button.

* The chosen operation is encircled by a frame.



3. Align with "tap" via the ▼ button, and select operation "Normal" with ▶ button.

* The chosen operation is encircled by a frame.



4. Select "Back roll" with ▼ button and "Partial" with ▶ button.

* The chosen operation is encircled by a frame.



5. Press the 決定 button to operate.

<Note>

Select the massage type using ▲▼ buttons, if ▶ button is pressed the combinations of available massage types are displayed.

[Example]

If "Neck roll" is selected, "Tap (Normal)" or "(Soft)" can be selected.



To cancel the selection of a massage operation while setting an operation

Press ▶ button to cancel a framed operation which is selected.

To Customize

● To adjust the upper and lower positions of the massage heads



Press ▲ ▼ buttons to adjust.

- Each press moves the massage heads approximately 1.5 cm.
- When you hold down the button, the operation will continue until you release it.



Flashing indicates the approximate current position.

● To adjust the massage width

Just operates with the “tap” and “back roll” massages.



Press ◀ ▶ buttons to adjust.

- The narrowness or broadness of the width can be adjusted.

● When using the leg/foot (heat/air) massage simultaneously

Press the **小腿·脚部** button.

(See step 2 on page E21.)

To change the content of the massage

● To change from a “MANUAL” operation

Press the **随心选择** button and select operations from the types of massage.

(See page E19.)

● To change to “FULL BODY” massage

Press the **自动程序** button, and select a program.

Upper body massage will stop temporarily.

(See page E15.)

● To change to “SELECTED AREA” massage

Press the **部位集中** button, and select a program.

Upper body massage will stop temporarily.

(See page E18.)

Depiction of a massage in progress



The currently functioning operation is displayed.
Combination of Tap (Soft) and Back roll (Full)
The width of the massage heads can be adjusted

USING LEG/FOOT (HEAT/AIR) MASSAGE

For a person with sensitive skin, wear thick socks.

1. Press the **关/开** button to turn on the power.

2. Press the **小腿·脚部** button. The leg/foot massage begins.

- The massage begins with the intensity at “2” and heat function “on”.
- When the upper body massage is not being used, even if **小腿·脚部** button is pressed, “Off” cannot be set.
- Press the **气囊** button without pressing the **小腿·脚部** to use the air massage only.
- The **温热** button cannot be used alone.



To adjust the intensity of the leg/foot massage



Press the **气囊** button to adjust the intensity.

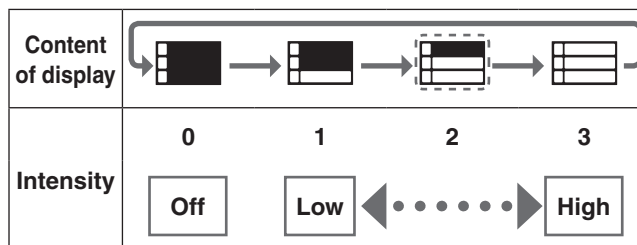

When the upper body massage is not being used, it can not be turned off the leg/foot massage section with the **气囊** button.

To turn off the “Heat” function



When **温热** is pressed, it can be toggled back and forth between “On” and “Off.”

The **温热** cannot be used alone without operating the upper body massage or **气囊**.

Leg/foot massage duration

To use leg/foot massage only:

The massage lasts for approximately 15 minutes.

To combine with upper body massage: When the upper body massage ends, the leg/foot massage ends simultaneously.

For a person with large body dimensions

If the slide of the sole massage section is adjusted, your knees will not be lifted as much.

Push with the soles of your feet to slide the leg/foot massage section out.

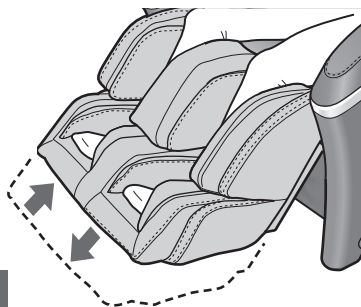

Lift your soles slightly and leg/foot massage section returns.

Operations of leg/foot (heat/air) massage

Calf

Calves will be compressed by pressing against from both sides.

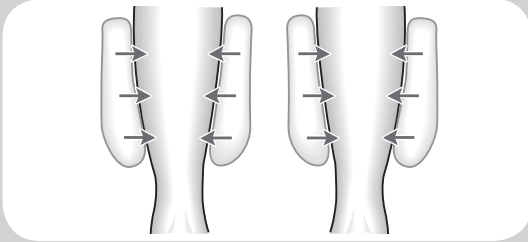

Sole

Position your feet in the footrests so that the shiatsu nodules are in contact with the soles of your feet.
Foot will be compressed from bottom using the shiatsu projections.

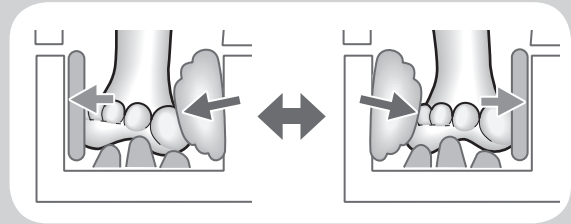

This operation warms up the soles and makes you feel comfortable.
You can feel warmer by laying a lap blanket, etc.

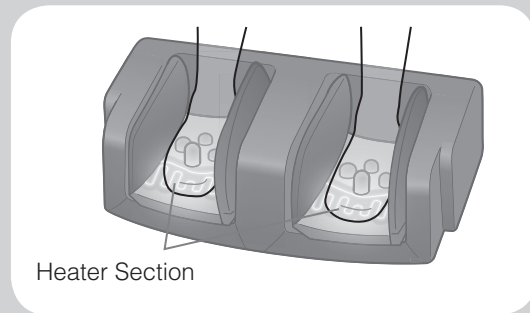

The heat alone cannot be used.

END THE MASSAGE

Timer function

The massage will complete automatically approximately 15 minutes after the start of operations.

- The leg/foot massage section will be lowered automatically
- The massage heads move to the retracted position.
- Backrest will not rise automatically.
Backrest will rise by pressing **关/开** button twice.

Interrupting the massage

Press the **关/开** button.

- The leg/foot massage section lowers automatically. The massage heads move to the retracted position.
- The backrest will rise after the massage heads retract.

If you experience any problems

Press the **紧急停止** button.

- All operations will stop immediately.
- Get off the unit carefully to prevent the unit tipping over.

Slide back the leg/foot massage section

- ⚠ • Do not let children use the unit. Also, do not let children play on the unit or climb onto the leg/foot massage section, seat, backrest or armrest.
Doing so may result in accident or injury.

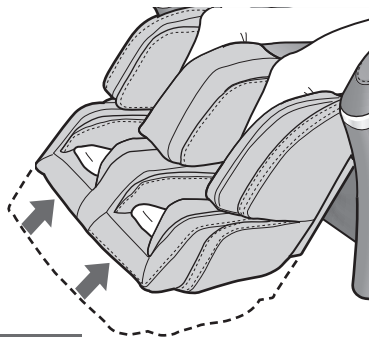

Lift your soles slightly and leg/foot massage section returns.

Disconnecting the power

- ⚠️ • Store the lock switch key out of the reach of children.
Failure to observe this may result in accidental swallowing, or accident or injury due to tampering.
- After use, be sure to slide the power switch to the “off” position and turn the lock switch to the “lock” position, and remove the key and power plug.
Failure to observe this may result in accident or injury due to tampering by children.
- When unplugging the unit, always hold the power plug and not the power cord.
Failure to observe this may result in electric shock or short circuit.
- Unplug the power plug from the outlet when not in use.
Failure to observe this may lead to insulation failure due to dust and humidity, and cause fire due to electric leakage.
- Do not allow children to use the controller holder clamp screw.
Failure to observe this may result in accidental swallowing, or accident or injury due to tampering.

1 Slide the power switch to the “off” position.

2 Turn the lock switch key to the “lock” position.

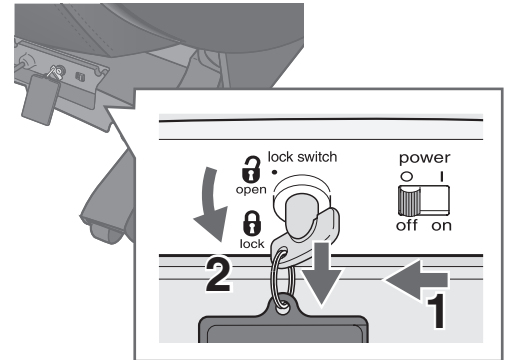

3 Remove the power plug from the electrical outlet.

4 The lock switch key must be stored out of the reach of children.

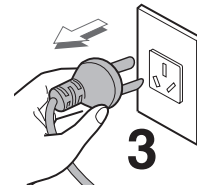

CLEANING AND MAINTENANCE

- ⚠ • Unplug the power plug from the outlet when cleaning the unit and replacing the covers.
Failure to observe this may result in electric shock or injury.

Never use chemicals such as thinner, benzene, alcohol, etc.



Synthetic Leather, Plastic Area

Routine cleaning and maintenance

Wipe off dust and mild dirt with a soft dry cloth.

When dirty

- 1 Soak a soft cloth in water or a mild detergent diluted to 3 – 5 % with warm water, and wring out thoroughly.



- 2 Wipe the surface.
(Wipe the fabric parts and synthetic leather with a patting motion.)



- 3 Wipe off the cleaning fluid with a cloth moistened with water only and thoroughly wrung out.
- 4 Wipe with a dry, soft cloth.
- 5 Allow the unit to dry naturally.
(Do not rapidly dry using dryers, etc.)





When the dirt is not easily removed







Try the following methods during Step 1.

<For synthetic leather>

Wipe with commercially available "melamine foam sponge" soaking mild detergent.

Q&A

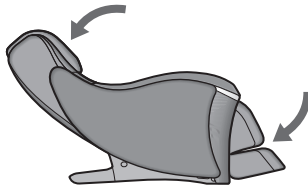
Q:	Can I use the unit if I am going to hospital due to an illness?
A:	Consult with your physician before using the unit. Massaging uses “contact pressure stimulation” to relax the muscles by applying pressure and to improve blood circulation. Please be sure to consult with a physician, as this may worsen symptoms depending on the illness. (See pages E3 to E5)
Q:	How tall do I need to be to use the unit?
A:	As physique varies among individuals, refer to the following rough guideline. If a person shorter than about 150 cm or taller than about 185 cm use the upper body massage and leg/foot massage at the same time, their feet may not reach the sole section or the person may feel cramped. * For a person short in height using the “自动程序 (FULL BODY)” mode, who have trouble in raising the leg/foot massage section, using the unit by raising the backrest and the leg/foot massage section to the upright position could improve the massaging effects.
Q:	When massaging, how do I use the pillow?
A:	When massaging, use the pillow as follows: <ul style="list-style-type: none"> • Normally, adjust the pillow height so that the bottom edge is at ear level. • When feeling that the massage on the neck and shoulders is not intense enough, you can flip the pillow. Try to massage without the pillow. 
Q:	The intensities on the left and right sides feel different.
A:	It may feel different due to the structure of the unit. Because an alternate tapping method is employed to give a massage that feels natural, the massage heads may not move in a uniform manner. Therefore, the intensity on the left and right sides may feel different, but this is not a malfunction.
Q:	Sometimes it feels as if the massage heads are bouncing behind my back, is this okay?
A:	To experience the massage more softly, this unit adopts the kneading float mechanism. Depending upon your physique and how you are sitting, you might feel as if the massage heads are bouncing as they move, since the mechanism moves as such, this is not a malfunction.
Q:	Does the displayed remaining time vary with the program?
A:	Yes, the displayed remaining time varies. The timer will set a time when you press the 关/开 button and then select a program.  <ul style="list-style-type: none"> 自动程序 About 15 minutes except for Quick (8 min). 部位集中 About 15 minutes. 随心选择 About 15 minutes. 小腿·脚部 About 15 minutes for leg/foot massage only. When being combined with upper body massage, it will be set to the upper body massage time. <p>* When changing programs in the middle of the operation, the massage will continue only for the remaining time displayed because the timer has already been set.</p>

Q:	Why doesn't the backrest return to its original position after finishing the massage?
A:	When the massage ends with the timer, in accordance with the settings, the backrest does not become upright to maintain the reclining position. To return the massage lounge to its original position, press the  button on the controller twice and the chair will automatically returns to its original position.
Q:	The sole shiatsu is too intense...
A:	Use the  button to change the intensity to [1]. In addition, the sole shiatsu intensity is diminished by lowering the leg/foot massage section.
Q:	When using the unit, how much power is consumed per month?
A:	If the unit is used 30 minutes (15 minutes a time, twice a day) per day for 31 days a month, the power consumption is about 2 kwh.
Q:	The operating sound is noisy...
A:	The unit makes sounds such as operating sounds of the massage function due to its structure. (See the top of page E29 for details) It may be a malfunction if the sound becomes louder, so please request a dealer for an inspection/repair.
Q:	Is the sound using the leg/foot massage normal?
A:	For the leg/foot massage of this product, the massage is reformed by using air pressure. The product's internal air pump pumps air, and the solenoid valve intakes and exhausts the air. Thus, generated sound is not a problem. If the sound is extremely loud, the massage lounge might be malfunctioning. If this occurs, request the dealer or service center to carry out an inspection and repairs.
Q:	What should I be careful of when transporting the unit, such as in a move?
A:	<p>Please be careful of the following points.</p> <ul style="list-style-type: none"> • Make sure the backrest is fully reclined to facilitate the transport. • Do not move the unit with a person sitting on it. <p>1. Press the  button to turn on the power. 2. Press the  buttons to fully recline the backrest.</p>  <p>Keep pressing these two buttons until you hear a beeping sound. * You will hear a beeping sound when the leg/foot massage section is folded away, but keep pressing the buttons until the backrest is fully reclined.</p> <p>3. Press the  button to turn off the power and remove the power plug from the outlet (See page E24)</p> <ul style="list-style-type: none"> • If packing carton is not available, use packing material to protect the unit from scratches and as an anti-vibration measure, and handle with care. • When packing the unit, check that the power cord is not tangled around the unit, and place it on the seat so that it does not drag on the ground while moving the unit.

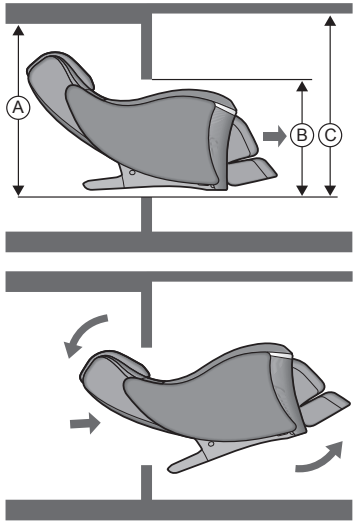
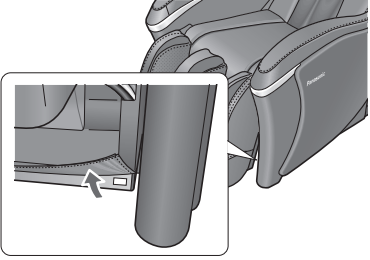
Q:	When transporting the unit what should I do, if it cannot pass through the door?	
A:	<p>Please try the following methods:</p> <ul style="list-style-type: none"> • Before moving the unit into the room, please confirm that there is enough space nearby the doorway. When moving the unit in, please be careful not to let the unit touch the wall or the pillar nearby. • The unit can be moved sideways through doorways which are less than 79 cm in width. In this case, confirm the following dimensions. <ol style="list-style-type: none"> 1. Put the unit horizontally, and move it little by little through the door. <ol style="list-style-type: none"> A) The width of the space outside the door: The width from the wall to the doorframe on the opposite side has to be more than 90 cm. B) The width of the door: It has to be more than 70 cm. C) The width of the space behind the door: The width from the wall to the doorframe on the opposite side has to be more than 100 cm. 2. Pass through the door while rotating the unit. <ul style="list-style-type: none"> * When the width of the door is less than 70 cm, do not open the packing carton by yourself. Please contact the service center about how to move the unit into the room. (Please refer to the figure on the right.) 	
Q:	Where can I find the serial number of the product?	
A:	<p>Raise the Leg/Foot massage section, and you will find the serial number under the seat of the unit.</p> 	

TROUBLESHOOTING

Inspect and remedy the following items.

Contact the service center if something is still wrong after attempting to remedy a problem.

Problem
▶ Cause and Remedy
Motor Noises
1. Operational noises in the kneading region (upper body) <ul style="list-style-type: none"> • The massager's kneading and tapping operational noises • Operational noises while the massager moves up or down • Squeaking noises when the kneading region is under a load • Motor sounds, belt revolving sounds 2. Reclining operational noises 3. Foot massager region operational noises 4. Air massager swivable section <ul style="list-style-type: none"> • Pump operational noises • Air discharging sounds. • Solenoid valve switchover sounds 5. Vibration when the reclining operation commences
▶ These sounds are perfectly normal and will not have any effect on the operation of the unit.
The massage heads stop during operation. (When the unit beeps, the operation display on the controller goes out and operations stop.)
▶ <u>When excessive force is applied to the massage heads during operation, in the interests of safety the massage heads may stop moving.</u> When the massage heads has stopped, turn off the power of the unit once, turn "on" the power again after approximately 10 seconds, and then operate the unit. If the massage heads stop again, position yourself so that your back is not completely in contact with the backrest. (For those who weigh 120 kg or more, especially pay attention to use of the unit.)
It is not possible to recline the unit. The leg/foot massage section cannot be raised or lowered. (When the unit beeps, the operation display on the controller goes out and operations stop.)
▶ <u>If the unit encounters an obstacle or if excessive force is exerted on it during operation, in the interests of safety the unit will come to a stop.</u> When the backrest or the leg/foot massage section has stopped, turn off the power of the unit once, turn "on" the power again after approximately 10 seconds, and then operate the unit.
The massage heads do not come up to the shoulder or neck.
▶ If your head or your back does not contact the backrest, the shoulder position may be detected as lower than the actual position during the shoulder checking operation. Sit on the seat in the deepest position and put your head on the backrest, and then repeat the operations again from the start. (See Pages E15 and E16.)
The height of the left and right massage heads is different.
▶ An alternating tapping method is employed, which means that this phenomenon will naturally occur. There is nothing wrong with the unit. (See page E26.)
The unit will not operate at all.
<ul style="list-style-type: none"> • Upper body (neck to lower back) massage • Calf and sole massage ▶ <ul style="list-style-type: none"> • The power cord has been disconnected. • The power switch on the unit has not been turned on. • A menu selection button or 小腿·脚部 button hasn't been pressed after pressing 关/开. (See Page E12.)
The heat sections at the sole massage area do not get warm.
▶ <ul style="list-style-type: none"> • The 温热 button is set to Off. • Sense of warmth from the heater sections will differ depending on your body shape, massage area, massage action, clothing, and ambient temperature. You can feel warmer by laying a lap blanket, etc.
The heat sections at the sole massage area do not cool down even after the "Heat" setting is turned off.
▶ <ul style="list-style-type: none"> • Because of the structure of the heater, the heat section will feel warm for a while after heating due to the residual heat. • The temperature you feel may rise when you massage the same area for a long time even if the "Heat" setting is set to Off.
The heater section does not turn "on" although the 温热 button has been pressed.
▶ <ul style="list-style-type: none"> • If neither the upper body massage nor the leg/foot massage is operating, 温热 cannot be used alone. (See page E21.)

Sometimes the power won't turn on when **关/开** is pressed again when a massage has finished.

▶ Approximately 5 seconds are required for program termination after a massage finishes. Wait at least 5 seconds once all movement has stopped before pressing **关/开**.

The unit has been damaged.

▶ Stop using the unit immediately.

The power cord or power plug is abnormally hot.

▶ Stop using the unit immediately.

Error display

Error display	Contents
F11 F12	▶ Operation is terminated because there is a problem with internal communication.
F04 F05 F06 F08	▶ Operation is terminated because there is a problem with the leg/foot massage section.
F14 F33 F36 F37 F80 F81	▶ Operation is terminated because there is a problem with the kneading float mechanism.
F15 F16 F34 F35	▶ Operation except for the massage mechanism is terminated because there is a problem with the reclining mechanism or the raise/lowering mechanism of the leg/foot massage section.
U10	▶ To be safe, if someone cannot be confirmed to be seated, operations will stop. If an error occurs although someone is seated, after pressing 紧急停止 , have the person reseal themselves deep against the backrest and restart the operation.

* Please contact an authorized service center. (Check the guarantee for the phone number to the service center.)
Service and maintenance will be carried out smoother if the error number is communicated when contacting.

- ⚠
- Never attempt to remodel the unit. Also, do not attempt to disassemble or repair the unit yourself. Doing so may result in fire, abnormal operation or injury.
 - If the unit does not work or if an abnormality is felt, stop using it immediately, unplug the unit and request an inspection/repair.
Failure to observe this may result in electric shock or fire.

松下住宅电器(上海)有限公司

Panasonic Manufacturing (Shanghai) Co., Ltd.

<http://www.panasonic.net/>

制造商: 松下住宅电器(上海)有限公司

上海市松江工业区江田东路258号

原产地: 中国

No.1 CH, EN

发行: 2012年11月

中国印刷

P9310MA01491 Printed in China