

Panasonic®

使用说明书
Operating Instructions
电动理发器
Hair Clipper

型号
Model No. ER-CA70/ER-CA65/ER-CA35

中文	2
English	8
保修证	13

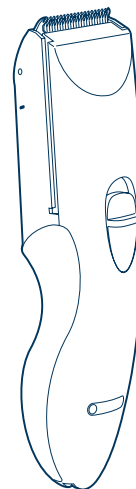

Before operating this unit, please read these instructions completely and save them.
在使用本产品前，请仔细阅读本说明书并妥善保管，以备将来参考。

安全说明

不遵守该安全说明可能会导致短路、火灾、触电、造成严重人身伤害甚至死亡。

▶使用变压器时需要小心

- 清洁理发器时应从插座中拔出变压器。
一切记要用手抓着变压器拔出，不可拉着电源线拔出。
- 电源线或变压器破损时或者变压器不能完全紧贴插入插座时，请勿使用理发器。
- 不能使电源线受损或变形。请勿将重物放置在电源线上或者使其它物体卡住电源线。
- 定期为电源插座清除灰尘。
- 电源线不能更换，如果电源线损坏，此器具应废弃。

▶远离液体

- 请勿在浴室中使用理发器的交流工作模式。
- 请勿用湿手插拔变压器。
- 请勿让变压器沾触液体。
- 请勿用稀释剂、苯精或酒精擦拭理发器或变压器。

▶不遵守以下注意事项可能会导致皮肤损伤

- 请勿将刀刃压住皮肤。
- 请勿将理发器用于理发之外的用途。
- 请勿用于宠物。
- 使用前请检查刀刃是否受损或变形。
- 每次使用前，请在箭头指示之处注油。（见第6页）

▶充电注意事项

- 连续充电超过48小时可能会缩短电池的寿命。
- 理发器在使用与充电过程中可能会稍微发热。这种情况属于正常现象。
- 请在5℃-35℃的环境中充电，以便理发器能够正常工作。
- RE9-37变压器只能与本型号配合使用，不能用于其它的产品或用途。

▶使用与藏储注意事项

- 不能拆卸或改装理发器。请勿尝试修理。
- 修理必须由Panasonic指定维修中心进行处理。
- 本品不宜供肢体、感官或精神上有残疾者、缺乏经验和知识者（包括儿童）使用，除非有人对此类人加以监督或者对本品的使用加以指导，且对使用者的安全能承担责任。
- 请妥善处理本产品的包装袋，避免婴幼儿窒息等意外发生；请置于儿童触摸不到的地方，请勿让婴幼儿及儿童接触润滑油。请对儿童进行监督，避免其将产品视为玩具，引发危险。
- 本理发器只适于室内使用。
- 请勿将理发器暴露直射阳光之下，或者放置于加热器或其它热源的附近。
- 本产品专为家庭使用而设计。

型号规格

产品名称：电动理发器
 产品型号分别是：ER-CA70/ER-CA65/ER-CA35
 变压器额定电压：a. c100-240V ~ 50-60Hz
 变压器额定电流：110mA
 变压器输出：d. c1. 9V --- 1. 4A
 理发器额定电压：d. c1. 2V
 充电时间：8h
 原产地：中国
 生产日期：见商品上刻印
 执行标准：GB4706.1附录B、GB4706.9、Q/SXDGWB 6

松下电工·万宝电器(广州)有限公司
 广州市番禺区市广路万宝基地
 邮政编码:511495 电话:020-84770333(总机)

注:以上规格若有变更,恕不另行通知。

各部分名称

- Ⓐ 刀刃
- Ⓑ 配件安装处
- Ⓒ 开关
- Ⓓ 充电指示灯
- Ⓔ 3/6mm 定长配件
- Ⓕ 9/12mm 定长配件
- Ⓖ 15/18mm 定长配件
- Ⓗ 自然修剪配件
- Ⓘ 鬓角修剪配件
- Ⓝ 削发 (1/3) 配件
- Ⓚ 20/30/40mm 定长配件
- Ⓛ 50/60/70mm 定长配件
- Ⓜ 清洁压柄
- Ⓝ 变压器 (RE9-37)
- Ⓞ 电源线
- Ⓟ 润滑油
- Ⓠ 清洁刷

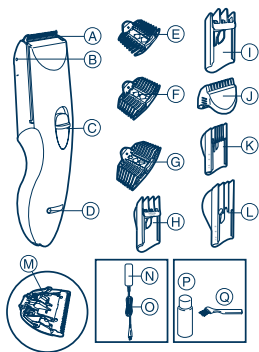

配件	ER-CA70	ER-CA65	ER-CA35
3/6mm 定长配件	√	√	√
9/12mm 定长配件	√	√	√
15/18mm 定长配件	√	-	-
自然修剪配件	√	√	-
鬓角修剪配件	√	-	-
削发 (1/3) 配件	√	√	-
20/30/40mm 定长配件	√	√	√
50/60/70mm 定长配件	√	√	-

充电

充电

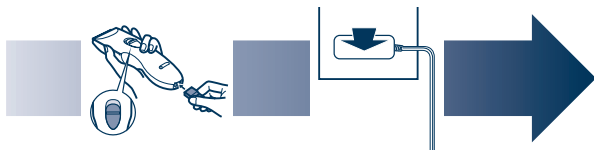

1. 将开关置于显示 [0 · CHARGE] 位置后，将电源线插入理发器。
2. 将变压器插入电源插座。充电指示灯将会亮起。
3. 充电结束后将变压器拔出电源插座。

- 充电时间为 8 小时。
- 充满电后可持续工作约 40 分钟。
- 购买后初次使用或半年以上未使用过，请充电 16 小时 (要激活充电电池活性)，如果充电池完全放电后充电，充电指示灯可能不会亮，继续充电几分钟后即正常。

插入配件

- ▶ 20/30/40mm, 50/60/70mm 定长配件

1. 当开关置于显示 [0 · CHARGE] 位置时，推动配件调整至所需的长度，每个长度到位时，都会听到“咔嗒”声。

- 配件应置于正确的位置。否则，开关不能置于显示“1”的位置。同时当开关置于显示“1”位置时，该配件会被锁住。



- 实际剪下的头发长度将比设置的长度稍长。

女
母

▶3/6mm, 9/12mm, 15/18mm 定长配件

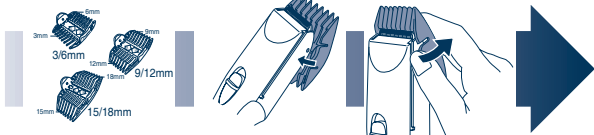

1. 选择合适的修剪定长配件(标明于配件内部与侧面)。
2. 按照图示将配件安装至理发器上。
3. 使用完毕后, 从理发器上卸下配件。

▶自然修剪配件和鬓角修剪配件

使用该配件从内侧修剪可削薄头发。将头发削薄并将发尖修剪至所需要的不同长度后, 头发便可呈现出自然的风格。

自然修剪配件:

适用该配件的头发长度为30mm至70mm。该配件不能修剪短于30mm的头发。

鬓角修剪配件:

适用该配件的头发长度最好短于30mm(用于修剪鬓角和耳朵周围的毛发。)

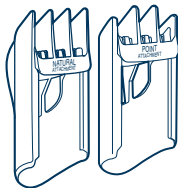

▶削发配件

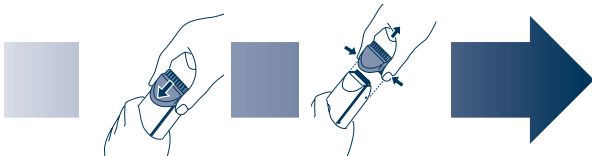

1. 按照图示将配件插装于刀刃之上。插装到位时, 会听到“咔嚓”声。
2. 需要卸下配件时, 请按住两侧向上拉配件。

理发

理发

- 1 使理发器背部沿着头发移动, 将头发修剪至适合的长度。

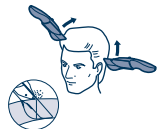

- 请勿反过来使用理发器。否则, 可能会修剪过度。



▶不带配件时的修剪

不带配件时，修剪后头发的剩余长度约为1mm。

1. 如图，用理发器刀头部分直接进行修剪。



▶交流工作模式

连接变压器至理发器（与充电的方式相同）后，将开关置于显示“1”位置处。此时即使电池电力不足，理发器亦可使用。

- 若理发器不能工作，请将开关置于显示“0·CHARGE”位置处，1分钟之后重新将开关置于显示“1”位置处。
- 使用内置电池理发时，开关置于“1”位置时，请勿过度用尽电池电量。这将导致电池寿命缩短。

护理

刀刃护理

如右图所示的标志表示本理发器可直接在水龙头下进行清洗。



安装与卸除刀刃

1. 手持理发器，使“Panasonic”标志向上。用一只手的拇指下压刀刃，另一只手接住刀刃。
- 卸下刀刃前，确保开关置于显示“0·CHARGE”位置。



2. 需要重新装上刀刃时，将刀刃尾部凸出部嵌入理发器的安装凹位扣，并将刀刃按如图所示方向压下直至听到“咔嚓”声为止。

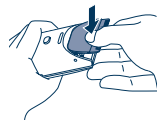

▶刀刃寿命

刀刃寿命取决于使用的频率与使用时间的长短。若每个月使用两次，每次20分钟，则刀刃的预期寿命约为两年。若刀刃维护得当，但理发效果下降时，请更换刀刃。

▶电池寿命

电池寿命取决于使用的频率与使用时间的长短。若电池每个月充电三次，则工作寿命约为3年。

- 长期不使用时，建议至少每六个月为理发器充电一次，以保证电池使用寿命。

清洁刀刃

- ▶若在水中清洗

警告 - 本理发器须与电源线分离后才能用水清洗。



1. 用水洗去刀刃上粘着的头发与理发器内的头发。
2. 将理发器轻轻抖动4、5次，擦去理发器与刀刃上的水珠之后放在毛巾上晾干，并使机身正面朝上。

✕
母

▶若用清洁刷进行清洁

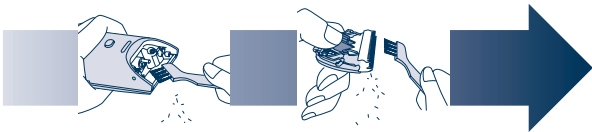

1. 用清洁刷将理发器中的头发与刀刃周围头发清除干净。
2. 卸下刀刃，用清洁刷清除刀刃上的头发。
3. 请按下清洁压柄抬高刀刃。用清洁刷清除固定刀刃与移动刀刃之间的头发。

▶用水或清洁刷清洁刀刃之后

1. 向箭头指示的各点注油数滴。
 2. 将刀刃重新装回理发器。
- 请使用之后向理发器滴油。否则，刀刃可能会钝、发出异常声响、发热并导致修剪效果降低。

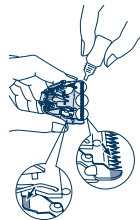

卸除内置可充电电池

- 本机内藏有可充电的镍氢电池，在消费者决定废弃本机时，一定要事先将电池从机器中取出。
- 分解器具，取出电池前，一定要断开电源。
- 鼓励消费者在决定废弃器具前，事先征求经销商或本公司指定维修点的意见，尽量延长器具的使用寿命。
- 当消费者决定废弃器具又不想自行分解机器取出电池时，鼓励消费者将本器具送往本公司指定的维修店，由维修店对电池进行分解和回收。
- 下列步骤示范如何取出电池以便处理：

- (1) 从变压器上拔出理发器。
- (2) 打开理发器开关直至刀刃停止动作为止。使电池充分放电。

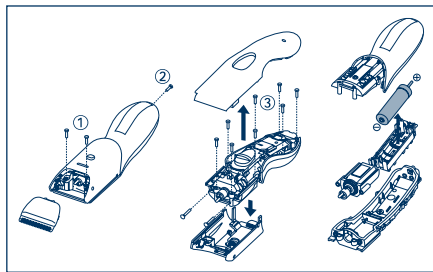

- (3) 按右图所示的①~③的顺序拆开本体，卸下电池。
 - (4) 卸下电池后，注意不能使电池的正负极出现短路连接。
- 电池务必废弃于政府规定的地方或回收处理单位。

Safety instructions

Failure to observe the Safety instructions may result in death, serious injury, electric shock, fire or short circuit.

► Be careful when handling the AC adaptor

- Disconnect the AC adaptor from the outlet when cleaning the clipper.
 - Always grip the AC adaptor and not the power cord.
- Do not use the clipper if the power cord or the AC adaptor is worn, or if the AC adaptor does not fit snugly in the outlet.
- Do not damage or deform the power cord. Do not place heavy objects on the power cord or trap it between objects.
- Clean the power plug regularly to remove any dust or dirt.
- The power cord cannot be replaced. If it is damaged, the AC adaptor should be discarded.

► Keep out of liquid

- Do not use the clipper with AC operation in bathrooms.
- Do not insert and remove the AC adaptor with wet hands.
- Do not allow the AC adaptor to get wet.
- Do not wipe the clipper or AC adaptor with thinner, benzine or alcohol.

► Failure to observe the following may result in injuries to the skin

- Do not press the blade against the skin.
- Do not use the clipper for any purpose other than trimming.
- Do not trim the hair of a pet.
- Check that the blades are not damaged or deformed before use.
- Before using each time, apply oil at the places marked with arrows. (See page 6.)

► Caution for when charging

- Charging for longer than 48 hours may shorten the life of the battery.
The clipper may become warm during operation and/or charging. This is normal.

- Charge the clipper at temperatures of between 5°C and 35°C for it to work correctly.

- Do not use any power cord or AC adaptor other than the one specifically designed for this model. (RE9-37)

► Caution for usage and storage

- Do not disassemble or modify the clipper. Do not attempt repairs.
 - Repairs must always be requested to your dealer.
- This appliance is not intended for use by persons (including children) with reduced physical, sensory or mental capabilities, or lack of experience and knowledge, unless they have been given supervision or instruction concerning use of the appliance by a person responsible for their safety. Children should be supervised to ensure that they do not play with the appliance.
- This clipper is for indoor use only.
- Do not store the clipper in a place exposed to direct sunlight or near a heater or other source of heat.

Specifications

Product Name: clipper

Model: ER-CA70/ER-CA65/ER-CA35

Adaptor rated voltage: a.c100-240V ~ 50-60HZ

Adaptor rated current: 110mA

Adaptor output: d.c1.9V $\overline{\text{---}}$ 1.4A

Clipper rated voltage: d.c1.2V

Charging time: 8 hours

Made in China

Production Date: Consult the date printed on product

This unit complies with the Chinese standard GB4706.1 appendix B, GB4706.9 and Q/SXDGW6

Panasonic Electric works Wanbao (Guangzhou)co.,Ltd.
Wanbao Base, Shiguang Road, Panyu District, Guangzhou
Post code: 511495 Tel: (020)84770333 (Switchboard)

- The above specifications may be subject to change without prior notice.

Parts identification

- (A) Blade
- (B) Attachment mounting
- (C) Switch
- (D) Charging indicator lamp
- (E) 3/6mm comb attachment
- (F) 9/12mm comb attachment
- (G) 15/18mm comb attachment
- (H) Natural cutting attachment
- (I) Point cutting attachment
- (J) Thinning (1/3) attachment
- (K) 20/30/40mm comb attachment
- (L) 50/60/70mm comb attachment
- (M) Lever for cleaning
- (N) AC adaptor (RE9-37)
- (O) Power cord
- (P) Oil
- (Q) Cleaning brush

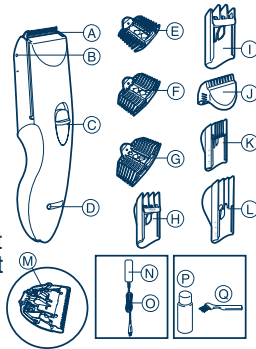

Attachments	ER-CA70	ER-CA65	ER-CA35
3/6mm comb attachment	✓	✓	✓
9/12mm comb attachment	✓	✓	✓
15/18mm comb attachment	✓	-	-
Natural cutting attachment	✓	✓	-
Point cutting attachment	✓	-	-
Thinning (1/3) attachment	✓	✓	-
20/30/40mm comb attachment	✓	✓	✓
50/60/70mm comb attachment	✓	✓	-

Charge

Charging

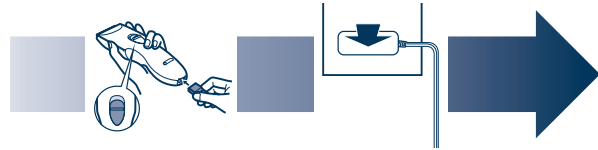

1. Set the switch to "0-CHARGE", and insert the power cord into the clipper.
2. Connect the AC adaptor into an outlet. The charging indicator lamp will light up.
3. Disconnect the AC adaptor from the outlet when charging is completed.

- The charging time is 8 hours.
- 1 full charge will provide approximately 40 minutes of continuous operation.
- The indicator lamp may take several minutes to become bright, when the charge has drained completely from the battery.

Inserting the attachment

▶ 20/30/40mm, 50/60/70mm comb attachments

1. Adjust the attachment to the desired trimming height by sliding it until it clicks while the switch is in "0-CHARGE".

- Set the attachment to the correct position. Otherwise you cannot set the switch to "1".
- Actual hair length will be a little longer than the height you set.

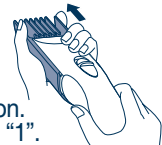

►3/6mm, 9/12mm, 15/18mm comb attachments



1. Select the cutting heights indicated on the insides and sides of the attachments.
2. Mount the attachment to the clipper as illustrated.
3. Remove the attachment from the clipper.

►Natural cutting attachment and Point cutting attachment

These attachments allow thinning of hair by cutting from the inner side. Hair volume is reduced, and hair tips are trimmed at various lengths to leave a natural look.

Natural cutting attachment:

Desirable hair lengths are 30 mm-70 mm (hair lengths shorter than 30 mm may be too short to cut in some situations.)

Point cutting attachment:

Desirable hair lengths are less than 30 mm (for cutting sideburns and around the ears.)

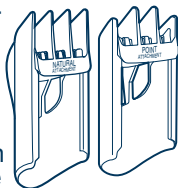

►Thinning Attachment



1. Insert the attachment over the trimming blades until it clicks as illustrated.
2. To remove the attachment, push both sides while pulling the attachment.

Cut

Cutting your hair

- 1 Cut hair to the correct height by moving the clipper back against the flow of the hair.

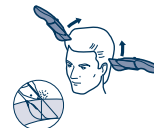

- Do not use the clipper in an inverted position. This can cut hair too deeply.



English

▶ Trimming with no attachments

Cutting without an attachment will trim hair length to 1 mm or less.

1. Cut hair by placing the clipper head directly on the scalp.



▶ AC operation

If you connect the AC adaptor to the clipper in the same way as for charging, and set to the switch to where “1” is visible, you can use it even if the battery capacity is low.

- If the clipper does not operate, set the switch to “0•CHARGE”, wait about 1 minute and then set it back to “1”.
- Be careful not to discharge the battery completely with the switch left in “1”. It causes the battery life to shorten.

Care

Blade maintenance

The following is the symbol for a washable clipper. The symbol means the hand-held part may be cleaned under water.



Mounting and removal of the blade

1. Hold the clipper with the “Panasonic” mark facing upward and push the blade with your thumb while catching the blade in your other hand.



- Be sure to set the switch to “0•CHARGE” before you remove the blade.

2. To remount the blade, fit the mounting hook into the blade mounting on the clipper and push in until it clicks.

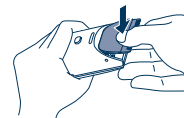

▶ Blade life

Blade life will vary according to the frequency and length of use. It is expected to be about 2 years when using the clipper twice a month for 20 minutes each time. If cutting efficiency is reduced despite proper maintenance, change the blades.

▶ Battery life

Battery life will vary according to the frequency and length of use. If the batteries are charged 3 times a month, the service life will be approximately 3 years.

- It is recommended that the clipper be recharged at least every 6 months even when not in regular use because the charge will drain from the batteries and their service life may be shortened.

Cleaning the blade

►If washing in water

Warning - Detach the hand held part from the power cord before cleaning it in water.

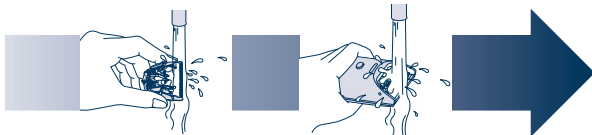

1. Rinse off any hairs sticking to the blade and any hairs inside the clipper.

2. Shake the clipper 4 or 5 times gently, wipe off any water drops from the clipper and blade, and then let it dry onto a towel with the "washable" indicator facing upward.

►If cleaning with brush

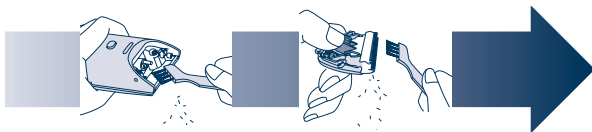

1. Brush off any hairs from the clipper and from around the blade.

2. Remove the blade and brush off the hairs from the blade edge.

3. Brush the hairs out from between the fixed blade and the moving blade while pressing down on the lever for cleaning to raise the moving blade.

►After cleaning the blade with water or brush

1. Apply a few drops of the oil to the points indicated by the arrows.

2. Remount the blade on the clipper.

• Apply the oil to the clipper after use. Otherwise the blades may become dull, make abnormal noises, or become hot and lead to the deterioration of cutting performance.

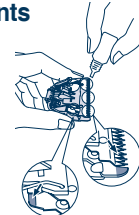

Removing the built-in rechargeable battery

Remove the battery as illustrated.

1. Disconnect the clipper from the AC adaptor when removing the battery.

2. Fully discharge the battery.

3. Disassemble hand held part as illustrated (①-③) then disattach the battery

4. Be careful not to short the + and - terminals of the battery after removing it.

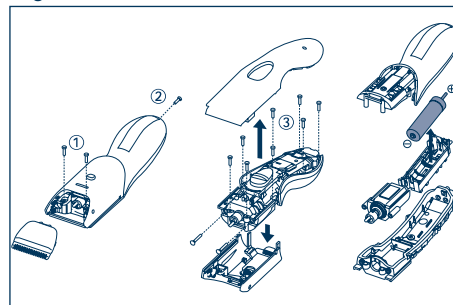

Important notice regarding environmental protection

The built-in rechargeable Nickel-Metal Hydride battery contains substances that may be environmentally harmful. Please remove the battery before discarding your clipper.

For environmental protection and recycling of materials

This clipper contains a Nickel-Metal Hydride battery. Please make sure that the battery is disposed of at an officially assigned location, if there is one in your country.

保修证

保修条款

- 有关保修期内Panasonic商品的保修（无偿修理），从购入之日起开始实施。
1. 保修期内的商品只可在Panasonic认定维修店进行保修；保修时，请出示本保修证及购机发票。
以下两点需特别注意：
 - a. 本保修证遗失后不再补发，请妥善保管。
 - b. 本保修证仅限于中华人民共和国国内有效（香港、澳门、台湾三地区暂不可使用）。
 2. 自购入之日起在以下期间内，在正常使用中发生故障的情况下进行保修。
 - 整机（除商用产品）·····2年内无偿
 - 整机（商用产品）·····6个月
 - 内刀头、外刀网、刀头、辅助装置、附件·····有偿提供
 3. 属下列情况之一者，即使在保修期内，也不能以保修对待，但是可以实行收费修理：
 - a. 未按商品使用说明书要求使用、维护、保管而造成损坏的；
 - b. 因不正确操作、电源不正常、破损（如：摔落等）而造成损坏的；
 - c. 不经Panasonic认定维修店维修人员拆动造成损坏的；
 - d. 不能出示本保修证及有效购机发票的；
 - e. 保修证上记录的信息与商品实物标识不符或者涂改的；
 - f. 因不可抗力因素（如雷电、地震、火灾、水灾等）造成损坏的。
 4. 本保修条款只适用于消费者个人为生活消费需要而购买使用的场合，不适用于经营性等使用。

[商品信息]

商品名称: 电动理发器 产地: 中国·广州

商品型号: ER-CA70/ER-CA65/ER-CA35 制造编号:

[保修回执] 以下回执是保修的重要依据，请勿自行撕下

商品型号: ER-CA70/ER-CA65/ER-CA35	制造编号:	保修结算 4
商品型号: ER-CA70/ER-CA65/ER-CA35	制造编号:	保修结算 3
商品型号: ER-CA70/ER-CA65/ER-CA35	制造编号:	保修结算 2
商品型号: ER-CA70/ER-CA65/ER-CA35	制造编号:	保修结算 1
商品型号: ER-CA70/ER-CA65/ER-CA35	制造编号:	促销员留存



保修证管理编码印刷处：

本保修证内容如有变更恕不另行通知

[销售记录] 不完整记录以下信息将可能无法进行保修

销售日期:	发票号码:	安装调试日期: 
顾客姓名:	联系电话:	
顾客地址:		邮 编:
销售店名称:	销售店电话:	
销售店地址:		邮 编:

[维修记录]

维修店名称:	联系电话:	送修日:
维修店地址:		邮 编:
故障内容:	故障原因:	
维修内容:		
维修员签字:	交验日期:	

维修店名称:	联系电话:	送修日:
维修店地址:		邮 编:
故障内容:	故障原因:	
维修内容:		
维修员签字:	交验日期:	

维修店名称:	联系电话:	送修日:
维修店地址:		邮 编:
故障内容:	故障原因:	
维修内容:		
维修员签字:	交验日期:	

Panasonic客户咨询服务中心:
400-810-0781; 800-810-0781 (固定电话)
Panasonic官方网站: <http://panasonic.cn>

松下电器 (中国) 有限公司

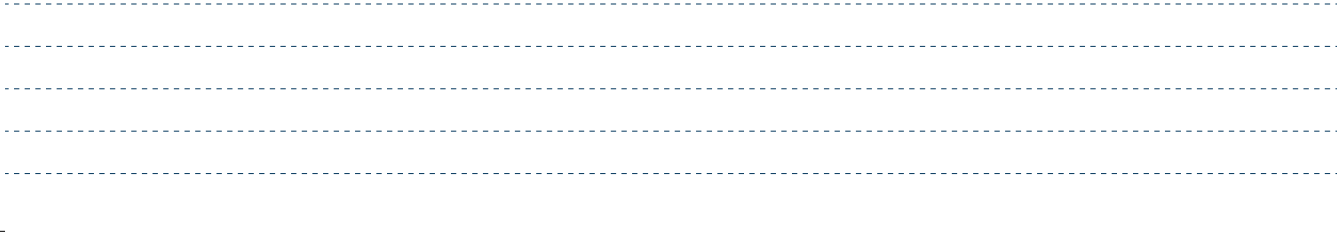

松下电工·万宝电器（广州）有限公司(PEWWBG)
Panasonic Electric Works Wanbao (Guangzhou) Co., Ltd.

工厂地址：广州市番禺区市广路万宝基地
(Address):Wanbao Base, Shiguang Road, Panyu District, Guangzhou
电话(Tel): (020)84770333
传真(Fax): (020)84773033
邮政编码(Post Code): 511495
原产地：中国

F. No.1 CH, EN(2009-1-20)

中国印刷
Printed in China