

# Panasonic®

使用说明书（另附保修证）  
Operating Instructions

（家用）电动剃须刀  
(Household) AC/Rechargeable Shaver

型号 ES-LT50/ES-LT20  
Model No.

---

中文 2

English 11



在使用本产品前，请仔细阅读本说明书并妥善保管，以备将来参考。

Before operating this unit, please read these instructions completely and save them for future use.

感谢您选购 Panasonic 剃须刀。请在使用前阅读所有说明。

## 重要事项

本剃须刀内置充电电池。不要将其丢入火中，加热或在高温环境中充电、使用或滞留。

### ► 使用剃须刀

#### 注意

因外刀网很薄，若使用不当就可能造成损坏。使用剃须刀前，请确认外刀网是否损坏。如果外刀网已损坏，请不要使用该剃须刀，因为这样会割伤皮肤。

- 请在出现异常或故障时终止使用。
- 使用充电器进行操作的情况下，不要用洗手液剃须或用水清洁。
- 不要与您的家人或其他人员共用。
- 本产品不宜供肢体、感官或精神上有残疾者、或缺乏经验和知识者（包括儿童）使用，必须有监护者从旁监督并对本产品的使用加以指导，且对使用者的安全能承担责任。请避免儿童将本产品视为玩具，从而引发危险。

### ► 充电

- 切勿在浴室或淋浴房使用充电器。
- 请不要使用除 RE7-51 充电器以外的任何电源线或充电器进行充电。
- 将充电器插入家用电源插座内进行充电，操作时双手应保持干燥。
- 从家用电源插座上拔出充电器时，不要用力拉电源线，因为可能会损坏电源线，应抓紧充电器的插头部位。
- 电源线不能更换，如果电源线损坏，此充电器应废弃。
- 充电的最佳环境温度为 15 至 35 摄氏度。

### ► 清洗剃须刀

#### 警告

用水清洗剃须刀前，请将剃须刀与电源线分离，以防触电。

- 请在装有两个内刀头的状态下进行清洗，若在仅装有一个内刀头的状态下进行清洗，可能会损坏剃须刀。
- 可用清水清洗剃须刀，不要使用盐水或热水。不要将剃须刀长时间浸泡在水中。
- 仅限使用稍稍蘸有自来水或肥皂水的软布清洁外壳。不要使用稀释剂、汽油、酒精或其他化学物品。

• 不要用水清洗充电底座。 **ES-LT50**

## ▶ 存放剃须刀

- 请在使用后将剃须刀存放在低湿度的地方。
- 不要将剃须刀存放在阳光直射或有其他热源的地方。
- 存放剃须刀时请拔出电源线。不要折弯电源线或将电源线缠绕在剃须刀上。
- 请妥善处理本产品的包装袋，避免婴幼儿窒息等意外发生。请置于儿童触摸不到的地方。请勿让婴幼儿接触润滑油。

## 各部分名称

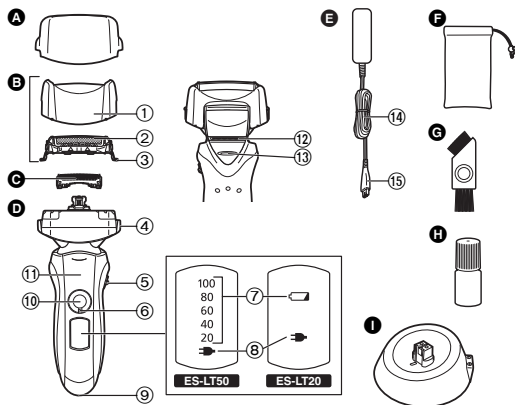

- A** 保护盖
- B** 外刀部
  - ① 外刀架
  - ② 外刀网
  - ③ 外刀网释放按钮
- C** 内刀头
- D** 机身
  - ④ 外刀架释放按钮
  - ⑤ 刀头浮动选择开关
  - ⑥ 锁环
  - ⑦ 电池电量指示灯
  - ⑧ 充电状态指示灯
  - ⑨ 电源线插孔
- E** 充电器 (RE7-51)
  - ⑩ 电源开关 [0/1]
  - ⑪ 指握位置
  - ⑫ 修剪刀
  - ⑬ 修剪刀操纵杆
  - ⑭ 电源线
  - ⑮ 电源线插头
- F** 旅行携带小包
- G** 清洁刷
- H** 润滑油
- I** 充电底座

**ES-LT50**

## 使用锁环

使用锁环上锁或启动电源开关。

1. 旋转锁环直至发出咔嗒的响声到位。



### 启动电源开关:

用于剃须、清洗剃须刀、或润滑剃须刀时



### 锁住电源开关:

用于随身携带剃须刀时

## 充电

### 给剃须刀充电

- 1 将充电器电源线插头与剃须刀连接。
- 2 将充电器插头插入家用电源插座里。

- 装载前请关闭剃须刀电源。
- 约 1 小时，即可完成充电。

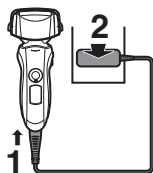

### 使用充电底座充电 ES-LT50

1. 将电源线插头插入充电底座。
2. 将剃须刀放置在充电底座上，然后将充电器插入家用电源插座。

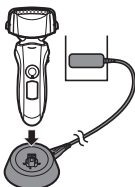

### 利用交流电剃须

- 当电池电量低时，您可将剃须刀通过充电器连接至家用电源插座，利用交流电进行剃须。
- 如果剃须刀不能正常使用，请充电约 1 分钟再使用。

## 充电时阅读指示灯

### 充电时

#### ES-LT50

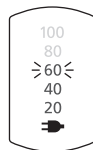

充电状态指示灯 (🔌) 发亮。  
随着充电的进行，电池电量指示灯的数字变大。

#### ES-LT20



充电状态指示灯 (🔌) 发亮。

### 充电完成后

#### ES-LT50

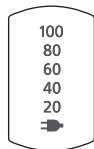

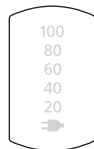

所有电池电量指示灯均会点亮，然后在 5 秒后熄灭。



#### ES-LT20



所有指示灯均熄灭。

- 充电的推荐环境温度为 15 至 35 摄氏度。在温度过低或过高的条件下，电池性能可能会下降或无法充电。充电故障时充电状态指示灯（）将会闪烁。
- 购买后初次使用或半年以上未使用过，充电状态指示灯（）可能不会立即亮，继续充电几分钟后即正常。

## 剃须

### 使用剃须刀

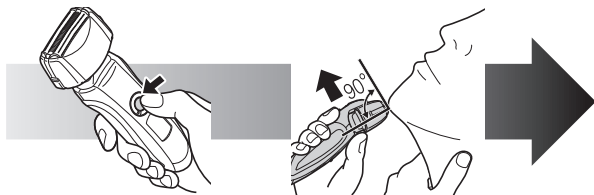

- 1** 旋转锁环并按下电源开关。
- 2** 如上图所示握住剃须刀剃须。

**第 3 页**

轻轻地压向面部开始剃须。用另一只手绷紧脸上皮肤，逆着胡须生长方向前后移动剃须刀。当皮肤适应剃须刀之后您可以稍稍加大压力，但施加压力过大就可能造成皮肤伤害。

### 注意

- 如果按下电源开关 2 秒钟以上，则会启动声波洗净模式。 **第 7 页**  
在此模式下不可剃须。
- 使用剃须刀时不要将手指放在电源开关上。这样会导致剃须刀关闭或进入声波洗净模式。使用剃须刀时将手指放在指握位置上。

### 刀头浮动选择开关

用来选择“SOFT”（柔和）或“LOCK”（锁定）。

不论剃须刀是否接通或关闭，你都可以改变刀头浮动模式。

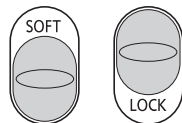

## 使用修剪刀

将修剪刀操纵杆往上推，以打开修剪刀。将修剪刀放置与皮肤成直角（90度）的位置，然后从上向下移动进行修剪。



## 使用时阅读指示灯

使用时

**ES-LT50**

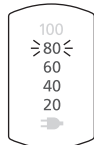

电池电量的近似值以20-100(%)进行显示。

- 使用交流电剃须时充电状态指示灯（）发亮。
- 操作开关后约5秒钟将会熄灭。

**ES-LT20**



电池电量不足时

**ES-LT50**

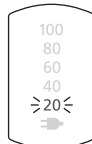

操作剃须刀时“20”闪烁。

- 电量显示“20”后您还可以使用剃须刀2到3次。（根据时间长短的不同使用次数也会有所不同。）
- 充足电后大约可提供14次剃须所需的电量。（以一次剃须3分钟计）

**ES-LT20**



操作剃须刀时电池电量指示灯（）闪烁。

- 电池电量指示灯闪烁后您还可以使用剃须刀2到3次。（根据时间长短的不同使用次数也会有所不同。）

## 清洁

### 清洗剃须刀

1. 将剃须刀上的充电器电源线插头拔出。
2. 在外刀网上涂抹少量洗手液和水。
3. 旋转锁环，启动电源开关。
4. 按下电源开关 2 秒钟以上以启动声波洗净模式。

• 电池电量指示灯依次闪烁。

#### ES-LT50

• 电池电量指示灯 (  ) 和充电状态指示灯 (  ) 交替闪烁。

#### ES-LT20

• 约 20 秒钟后，电源自动关闭，或者按电源开关可关闭电源。

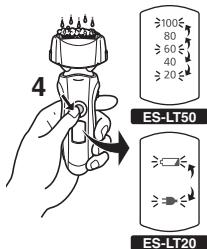

5. 取出外刀部，按下电源开关 2 秒钟以上启动声波洗净模式进行声波振动清洗。使用流动水来清洁。
6. 用干布拭去水珠。
7. 将外刀部和剃须刀完全擦干。
8. 将外刀部安装至剃须刀上。
9. 给剃须刀上润滑油。



左侧符号表示适合用在打开的水龙头下进行清洗。

### 警告

用水清洗剃须刀前，请将剃须刀与电源线分离，以防触电。

## 润滑

为长期保持剃须的舒适度，建议使用附赠的润滑油。

1. 关闭剃须刀电源。
2. 给每个外刀网滴一滴润滑油。
3. 推起修剪刀并滴一滴润滑油。
4. 启动剃须刀电源，运转约 5 秒钟。
5. 关闭剃须刀电源，使用软布将外刀网上多余的润滑油拭去。



## 使用清洁刷清洁

使用短刷，沿左图所示 (A) 的移动方向移动，清洁内刀头。  
使用长刷，清洁外刀网、剃须刀机身和修剪刀。

- 请勿沿 (B) 方向移动短刷，因为这样将损坏内刀头而影响刀片的锋利度。
- 请勿使用短刷清洁外刀网。

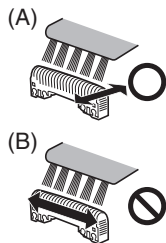

## 更换外刀网和内刀头

为了维持剃须刀的剃须性能，建议外刀网每年更换一次，内刀头每两年更换一次。

### ► 更换外刀网

1. 按下外刀架释放按钮并向上提起取出外刃部。
2. 按下外刀网释放按钮，拉出外刀网。
3. 对齐外刀架 (△) 标识和外刀网 (△) 标识然后稳固地安装在一起。
4. 将外刀架 (△) 标识转到前面以后，把外刀部稳固地安装到剃须刀直至其到位。



- 外刀网不能反向安装。
- 安装到剃须刀时，请确保外刀网插入到外刀架内。



## ► 更换内刀头

1. 按下外刀架释放按钮并向上提起取出外刀部。
2. 取下内刀头，一次取一个。
  - 不要触摸内刀头的边沿（金属部分），以防止您的手受伤。
3. 安装内刀头时，一次插入一个内刀头，直至固定位置为止。

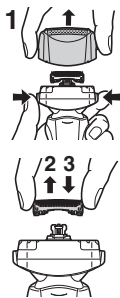

## ► 更换部件

更换部件在经销商或 Panasonic 认定维修店有售。

ES-LT50/ES-LT20 的更换部件	外刀网	WES9087
	内刀头	WES9068

## 内置式充电电池的取出方式

本产品内藏有充电电池，在消费者决定废弃本产品前，请务必将电池从本产品中取出。

- 分解本产品，取出电池前，一定要关闭电源。鼓励消费者在决定废弃本产品前，事先征求经销商或 Panasonic 认定维修店的意见，尽量延长本产品的使用寿命。
- 当消费者决定废弃本产品又不想自行分解本产品取出电池时，鼓励消费者将本产品送往 Panasonic 认定维修店，由维修店对电池进行分解和回收。
- 电池务必废弃于政府规定的地方或回收处理单位。

- 按下图所示的 ① ~ ④ 的顺序拆开本产品，卸下电池。

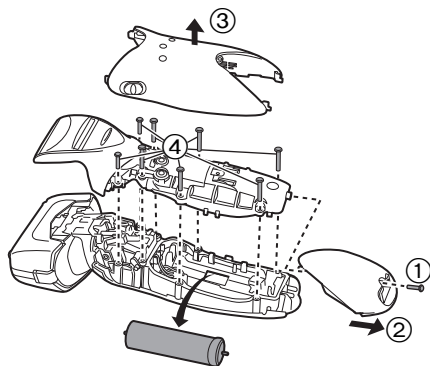

### 环境保护与资源回收

此剃须刀使用锂电池。

如果您的国家有相关规定，请务必在指定处对旧电池进行统一处理。

## 规格

产品名称	电动剃须刀
产品型号	ES-LT50/ES-LT20
充电器额定输入	100-240V~ 50-60Hz 180mA
充电器额定输出	5.4V--- 1.2A
马达电压	3.6V---
充电时间	约1小时
原产地	本机：日本 充电器：中国 充电底座 <b>ES-LT50</b> ：中国
生产日期	请见商品上刻印
执行标准	中国国家标准 GB4706.1附录B GB4706.9

本产品仅适合家庭使用。

**Thank you for choosing a Panasonic shaver.  
Please read all instructions before use.**

## Important

This shaver has a built-in rechargeable battery. Do not throw into fire, apply heat, or charge, use, or leave in a high temperature environment.

### ► Using the shaver

#### Caution

**The outer foil is very thin and can be damaged if not used correctly. Check that the foil is not damaged before using the shaver. Do not use the shaver if the foil etc. is damaged as you will cut your skin.**

- Terminate the usage when there is abnormality or failure.
- Do not shave with soap or clean it with water when operating with the adaptor.
- Do not share with your family or other people.
- This appliance is not intended for use by persons (including children) with reduced physical, sensory or mental capabilities, or lack of experience and knowledge, unless they have been given supervision or instruction concerning use of the appliance by a person responsible for their safety. Children should be supervised to ensure that they do not play with the appliance.

### ► Charging the shaver

- Never use the adaptor in the bathroom or shower room.
- Do not use any power cord or adaptor other than this adaptor (RE7-51).
- Plug in the adaptor into a household outlet where there is no moisture and handle it with dry hands.
- Hold the adaptor when disconnecting it from the household outlet. If you tug on the power cord, you may damage it.
- The supply cord cannot be replaced. If the cord is damaged, the adaptor should be scrapped.
- Adequate ambient temperature for charging is 15-35 °C.

### ► Cleaning the shaver

#### Warning

**Disconnect the power cord from the shaver before cleaning it in water to prevent electric shock.**

- Keep both the inner blades inserted. If only one of the inner blades is inserted, the shaver may be damaged.
- If you clean the shaver with water, do not use salt water or hot water. Do not soak the shaver in water for a long period of time.
- Clean the housing only with a soft cloth slightly dampened with tap water or soapy tap water. Do not use thinner, benzine, alcohol or other chemicals.
- Do not wash the charging stand with water.

**ES-LT50**

## ► Storing the shaver

- Store the shaver in a place with low humidity after use.
- Do not store the shaver where it will be exposed to direct sunlight or other heat sources.
- Disconnect the power cord when storing the shaver. Do not bend the power cord or wrap it around the shaver.
- Please properly store or dispose the plastic bag of the appliance to avoid any accidents, such as infants suffocation, etc. Keep the plastic bag away from infants. Keep the oil away from children.

## Parts identification

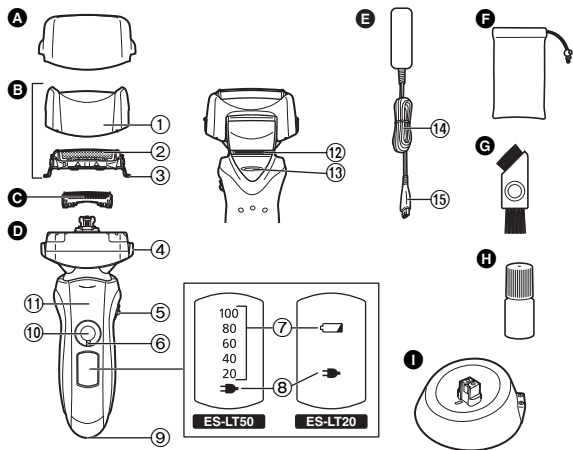

- A** Protective cap
  - B** Outer foil section
    - ① Foil frame
    - ② System outer foil
    - ③ System outer foil release buttons
  - C** Inner blades
  - D** Main body
    - ④ Foil frame release buttons
    - ⑤ Pivot action selector
    - ⑥ Lock ring
    - ⑦ Battery capacity lamp
  - E** Trimmer
    - ⑧ Charge status lamp
    - ⑨ Appliance socket
    - ⑩ Power switch [0/1]
    - ⑪ Finger rest
    - ⑫ Trimmer
    - ⑬ Trimmer handle
  - F** Adaptor (RE7-51)
  - G** Power cord
  - H** Appliance plug
  - I** Travel pouch
- ES-LT50**

## Using the lock ring

Use the lock ring to lock or unlock the power switch.

1. Rotate the lock ring until it clicks.



### Unlock the power switch:

For when shaving, washing the shaver, lubricating the shaver.



### Lock the power switch:

For when carrying the shaver.

## Charge

### Charging the shaver

- 1 Insert the appliance plug into the shaver.
- 2 Plug in the adaptor into a household outlet.

- Turn the shaver off before attaching.
- Charging is completed after approx. 1 hour.

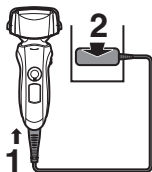

### Charging with the charging stand ES-LT50

1. Insert the appliance plug into the charging stand.
2. Place the shaver on the charging stand and plug in the adaptor into a household outlet.

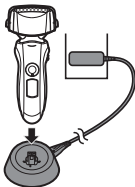

### Cord shaving

If you insert the appliance plug to the shaver and plug in the adaptor into a household outlet, you can use it even if the battery capacity is low.

- If the shaver does not work, continue charging it for approx. 1 minute.

## Reading lamps when charging

While charging

**ES-LT50**

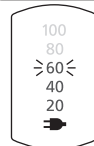

The charge status lamp (=>) glows. The number of the battery capacity lamp will increase as charging progresses.

**ES-LT20**



The charge status lamp (=>) glows.

After charging is completed

**ES-LT50**

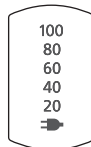

All the battery capacity lamps will light up and then turn off after 5 seconds.

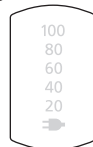

**ES-LT20**



All lamps turn off.

- Recommended ambient temperature for charging is 15-35 °C. The battery may degrade the performance or may not charge under extreme low or high temperatures. The charge status lamp (=>) will blink when there is a problem with charging.

- When charging the shaver for the first time or when it has not been in use for more than 6 months, the charge status lamp (➔) may not glow. It will eventually glow if kept connected.

## Shave

### Using the shaver

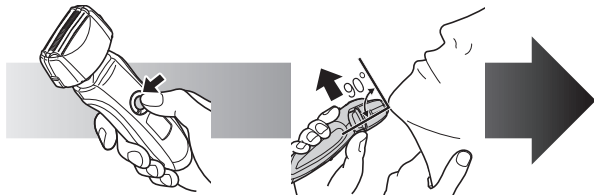

- 1 Rotate the lock ring and press the power switch.**
- 2 Hold the shaver as illustrated above and shave.**

**Page 12**

Start out shaving by applying gentle pressure to your face. Stretch your skin with your free hand and move the shaver back and forth in the direction of your beard. You may gently increase the amount of pressure as your skin becomes accustomed to this shaver. Applying excessive pressure does not provide a closer shave.

### Caution

- If you press the power switch for more than 2 seconds, the sonic vibration cleaning mode is activated. **Page 16**  
You cannot shave in this mode.
- Do not place your fingers on the power switch while using the shaver. This may cause the shaver to turn off or enter the sonic vibration cleaning mode. Place your fingers on the finger rest while using the shaver.

### Pivot action selector

Use to select “SOFT” (soft) or “LOCK” (lock).

You can change the pivot action whether the shaver is turned on or off.

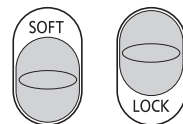

### Using the trimmer

Slide the trimmer handle up. Place at a right angle to your skin and move downwards to trim your sideburns.



## Reading lamps when using

While using

**ES-LT50**

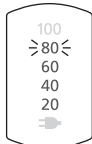

Approximate amount of battery charge is displayed as 20 - 100 (%).

- The charge status lamp (→) glows when using cord shaving.
- It will turn off approximately 5 seconds after operating the switch.

**ES-LT20**



When the battery capacity is low

**ES-LT50**

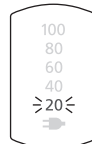

“20%” blinks when operating the shaver.

- You can shave 2 to 3 times after “20%” appears. (This will differ depending on usage.)

**ES-LT20**



The battery capacity lamp (↔) blinks when operating the shaver.

- You can shave 2 to 3 times after the battery capacity lamp (↔) blinks (This will differ depending on usage.)
- A full charge will supply enough power for approx. 14 shaves of 3 minutes each.

## Clean

### Cleaning the shaver

1. Disconnect the power cord from the shaver.
2. Apply some hand soap and some water to the outer foil.
3. Rotate the lock ring to unlock the power switch.
4. Press the power switch for more than 2 seconds to activate the sonic vibration cleaning mode.
  - The battery capacity lamps blink in order. **ES-LT50**
  - The battery capacity lamp (◁) and the charge status lamp (⇒) blink alternately. **ES-LT20**
  - After about 20 seconds, it will be automatically turned off, or you can turn it off by pressing the power switch.
5. Remove the outer foil section and press the power switch for more than 2 seconds to activate the sonic vibration cleaning mode and clean it with running water.
6. Wipe off any drops of water with a dry cloth.
7. Dry the outer foil section and the shaver completely.

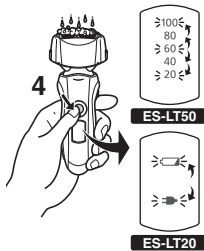

8. Attach the outer foil section to the shaver.
9. Lubricate the shaver.



The mark on the left means suitable for cleaning under an open water tap.

### Warning

**Disconnect the power cord from the shaver before cleaning it in water to prevent electric shock.**

### Lubrication

To maintain shaving comfort for a long time, it is recommended that the oil provided with the shaver is used.

1. Switch off the shaver.
2. Apply one drop of oil to each of the outer foils.
3. Raise the trimmer and apply a drop of oil.
4. Switch the shaver on, and run it for approximately five seconds.
5. Switch off the shaver, and wipe off any excess oil from the outer foils with a soft cloth.





## Cleaning with the brush

Clean the inner blades using the short brush by moving it in direction (A). Clean the system outer foil, the shaver body and the trimmer using the long brush.

- Do not move the short brush in direction (B) as it will damage the inner blades and affect their sharpness.
- Do not use the short brush to clean the outer foils.

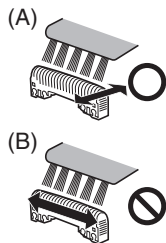

## Replacing the system outer foil and the inner blades

system outer foil	once every year
inner blade	once every two years

### ► Replacing the system outer foil

1. Press the foil frame release buttons and lift the outer foil section upwards.

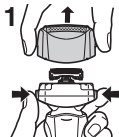

2. Press the system outer foil release buttons and pull down the system outer foil.
3. Align the foil frame mark (↗) and the system outer foil mark (△) and securely attach together.
  - The system outer foil cannot be reversely attached.
  - Always insert the system outer foil to the foil frame when attaching to the shaver.
4. After turning the foil frame mark (↗) to the front, securely attach the outer foil section to the shaver until it clicks.

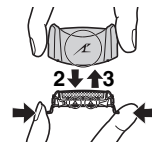

### ► Replacing the inner blades

1. Press the foil frame release buttons and lift the outer foil section upwards.
2. Remove the inner blades one at a time.
  - Do not touch the edges (metal parts) of the inner blades to prevent injury to your hand.
3. Insert the inner blades one at a time until they click.

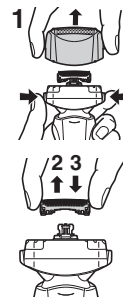

## ► Replacement parts

Replacement parts are available at your dealer or Service Center.

Replacement parts for ES-LT50/ES-LT20	System outer foil	WES9087
	Inner blades	WES9068

## Removing the built-in rechargeable battery

Remove the built-in rechargeable battery before disposing of the shaver. Please make sure that the battery is disposed of at an officially designated location if there is one. Do not dismantle or replace the battery so that you can use the shaver again. This could cause fire or an electric shock. Replace it at an authorized service center.

- Disconnect the power cord from the shaver when removing the battery.
- Perform steps ① to ④ and lift the battery, and then remove it.

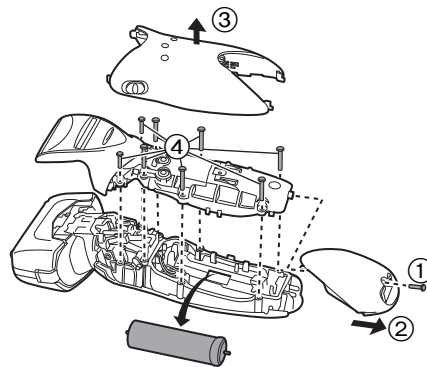

### For environmental protection and recycling of materials

This shaver contains a Lithium-ion battery. Please make sure that the battery is disposed of at an officially assigned location, if there is one in your country.

## Specifications

Product name	AC/Rechargeable Shaver	
Product model	ES-LT50/ES-LT20	
Rated input	100-240V ~ 50-60Hz 180mA	
Rated output	5.4V --- 1.2A	
Motor voltage	3.6V ---	
Charging time	Approx. 1 hour	
Place of origin	Main body: Japan Adaptor: China Charging stand <b>ES-LT50</b> : China	
Date of production	See engraving on the commodity.	
Execution standard	Chinese standard	GB4706.1 appendix B GB4706.9

This product is intended for household use only.

**进口商：松下电工（中国）有限公司**  
**地址：北京市朝阳区建国路79号 华贸中心2号写字楼6层、7层703室**  
**电话：86-10-59255988**  
**邮政编码：100025**

**制造商：松下电工株式会社**  
**地址：日本大阪府门真市大字门真1048番地**

**Panasonic Electric Works Co., Ltd.**  
**1048, Oaza Kadoma, Kadoma-shi, Osaka 571-8686, Japan**

**日本印刷**  
**Printed in Japan**  
**ES9700LT201K Y0510-0**  
**发行：2010年5月**