

Panasonic®

使用说明书（另附保修证）
Operating Instructions

（家用）电动剃须刀
(Household) AC/Rechargeable Shaver

型号 ES-LT70
Model No.

中文 2

English 17



在使用本产品前，请仔细阅读本说明书并妥善保管，以备将来参考。

Before operating this unit, please read these instructions completely and save them for future use.

感谢您选购 Panasonic 剃须刀。请在使用前阅读所有说明。

重要事项

本剃须刀内置充电电池。不要将其丢入火中，加热或在高温环境中充电、使用或滞留。

► 使用剃须刀

注意

因外刀网很薄，若使用不当就可能造成损坏。使用剃须刀前，请确认外刀网是否损坏。如果外刀网已损坏，请不要使用该剃须刀，因为这样会割伤皮肤。

- 请在出现异常或故障时终止使用。
- 使用充电器进行操作的情况下，不要用洗手液剃须或用水清洁。
- 不要与您的家人或其他人员共用。
- 本产品不宜供肢体、感官或精神上有残疾者、或缺乏经验和知识者（包括儿童）使用，必须有监护者从旁监督并对本产品的使用加以指导，且对使用者的安全能承担责任。请避免儿童将本产品视为玩具，从而引发危险。

- 曾接受过医疗电子仪器（如起搏器）移植手术的人士不允许将本设备接触此类仪器移植处的皮肤表面，否则会引发其功能障碍。

► 充电

- 切勿在浴室或淋浴房使用充电器。
- 请不要使用除 RE7-51 充电器以外的任何电源线或充电器进行充电。
- 将充电器插入家用电源插座内进行充电，操作时双手应保持干燥。
- 从家用电源插座上拔出充电器时，不要用力拉电源线，因为可能会损坏电源线，应抓紧充电器的插头部位。
- 电源线不能更换，如果电源线损坏，此充电器应废弃。

► 清洗剃须刀

警告

用水清洗剃须刀前，请将剃须刀与电源线分离，以防触电。

- 请在装有两个内刀头的状态下进行清洗，若在仅装有一个内刀头的状态下进行清洗，可能会损坏剃须刀。
- 可用清水清洗剃须刀，不要使用盐水或热水。不要将剃须刀长时间浸泡在水中。

- 仅限使用稍稍蘸有自来水或肥皂水的软布清洁外壳。不要使用稀释剂、汽油、酒精或其他化学物品。

► 存放剃须刀

- 请在使用后将剃须刀存放在低湿度的地方。
- 不要将剃须刀存放在阳光直射或有其他热源的地方。
- 存放剃须刀时请拔出电源线。不要折弯电源线或将电源线缠绕在剃须刀上。
- 请妥善处理本产品的包装袋，避免婴幼儿窒息等意外发生。请置于儿童触摸不到的地方。请勿让婴幼儿接触润滑油。

► 自动清洗 · 充电装置

- 不要在水里清洁充电器或自动清洗 · 充电装置，因为这会损坏它们或导致触电。
- 当使用“干燥”程序时不要将剃须刀从自动清洗 · 充电装置上拿开。因为使用了加热器，刀片周围会变得非常烫，可能会灼伤您。
- 请将自动清洗 · 充电装置放在平稳的表面上。否则清洁液会溢出并污染皮革品或其他表面。万一清洁液溢出，请立即进行擦拭。

- 自动清洗 · 充电装置可清洁内刀头和外刀网。请用清洁刷或水洗来清除未浸入清洁液或无法清洁区域所残留的胡须渣。
- 请在 15°C 到 35°C 之间的温度下使用自动清洗 · 充电装置。否则可能会发生下列问题。
 - 自动清洗 · 充电装置停止工作。
 - 在较低温度下使用自动清洗 · 充电装置，会缩短可充电电池的使用寿命。
- 请在低于 95% 的湿度下使用自动清洗 · 充电装置。
- 当您选择“干燥 / 充电”程序时，根据环境，剃须刀可能不会完全烘干。在这种情况下，请使用干布拭去水珠。

各部分名称

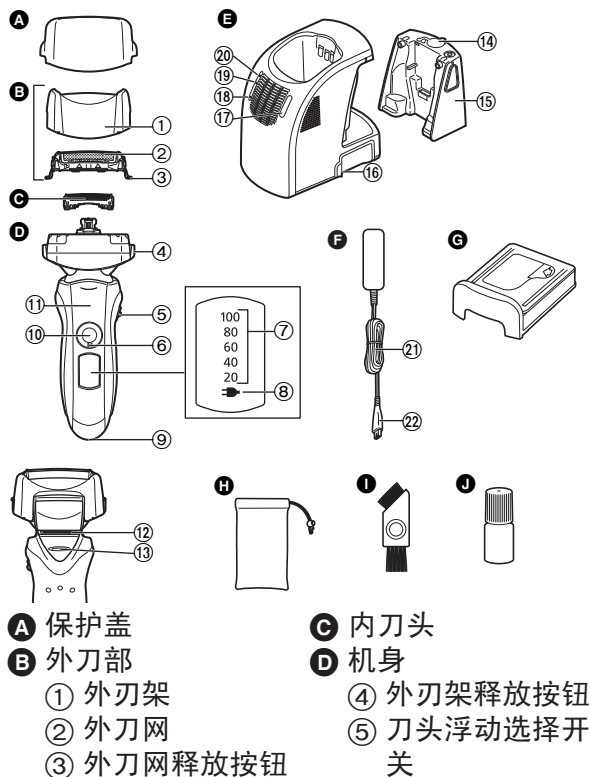

- ⑯ 干燥灯 (DRY)
⑰ 选择按钮
⑱ 状态灯 (STATUS)
⑲ 干燥灯 (DRY)
⑳ 清洁灯 (CLEAN)
㉑ 电源线
㉒ 电源线插头

使用锁环

使用锁环上锁或启动电源开关。

1. 旋转锁环直至发出咔嗒的响声到位。



启动电源开关:

用于剃须、清洗剃须刀、或润滑剃须刀时



锁住电源开关:

用于随身携带剃须刀时

充电

使用自动清洗 · 充电装置

请完全擦干自动清洗 · 充电装置上的水滴，保证其在充电前是干燥的。

- 1 将充电器电源线插头与自动清洗 · 充电装置连接。
- 2 将充电器接通电源。
- 3 取下保护盖，然后装上剃须刀。

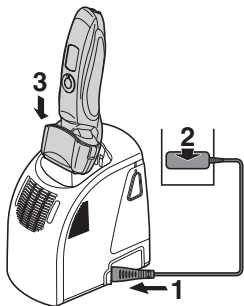

- 装剃须刀时“充电”进程将自动启动。
- 装载前请关闭剃须刀电源。
- 装剃须刀时请确认外刀网是否变形或损坏。
- 即使自动清洗 · 充电装置的状态灯 (STATUS) 闪烁也可充电。
- 约 1 小时，即可完成充电。

不使用剃须刀时，可以将剃须刀连接在自动清洗 · 充电装置上或充电器上，以维持电池充足的电量。无须担心过度充电。

电源线充电

不使用自动清洗 · 充电装置时也可进行充电。

1. 将充电器电源线插头与剃须刀连接。
2. 将充电器插头插入家用电源插座里。

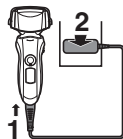

利用交流电剃须

当电池电量低时，您可将剃须刀通过充电器连接至家用电源插座，利用交流电进行剃须。

- 如果剃须刀不能正常使用，请充电约 1 分钟再使用。

充电时阅读指示灯

充电时

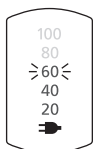

充电状态指示灯

(⚡) 闪烁。

随着充电的进行，电池电量指示灯的数字变大。

充电完成后

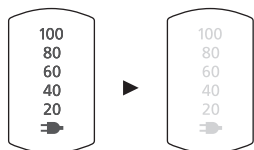

所有电池电量指示灯均会点亮，然后在 5 秒后熄灭。

- 充电的最佳环境温度为 15 至 35 摄氏度。在温度过低或过高的条件下，电池性能可能会下降或无法充电。充电故障时充电状态指示灯 (⚡) 将会闪烁。
- 购买后初次使用或半年以上未使用过，充电状态指示灯 (⚡) 可能不会立即亮，继续充电几分钟后即正常。

剃须

使用剃须刀

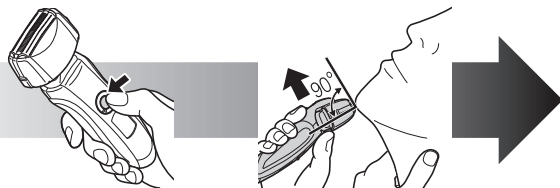

- 1 旋转锁环并按下电源开关。
- 2 如上图所示握住剃须刀剃须。

第 4 页

轻轻地压向面部开始剃须。用另一只手绷紧脸上皮肤，逆着胡须生长方向前后移动剃须刀。当皮肤适应剃须刀之后您可以稍稍加大压力，但施加压力过大就可能造成皮肤伤害。

注意

- 如果按下电源开关 2 秒钟以上，则会启动声波洗净模式。 **第 12 页**
在此模式下不可剃须。
- 使用剃须刀时不要将手指放在电源开关上。这样会导致剃须刀关闭或进入声波洗净模式。使用剃须刀时将手指放在指握位置上。

刀头浮动选择开关

用来选择“SOFT”（柔和）或“LOCK”（锁定）。

不论剃须刀是否接通或关闭，你都可以改变刀头浮动模式。

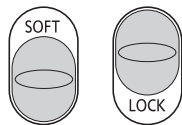
**使用修剪刀**

将修剪刀操纵杆往上推，以打开修剪刀。将修剪刀放置与皮肤成直角（90度）的位置，然后从上下移动进行修剪。

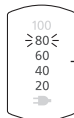
**使用时阅读指示灯****使用时**

- 电池电量的近似值以 20-100 (%) 进行显示。

- 使用交流电剃须时充电状态指示灯 () 发亮。
- 操作开关后约 5 秒钟将会熄灭。

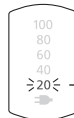
电池电量不足时

操作剃须刀时“20”闪烁。

- 电量显示“20”后您还可以使用剃须刀 2 到 3 次。（根据时间长短的不同使用次数也会有所不同。）
- 充足电后大约可提供 14 次剃须所需的电量。（以一次剃须 3 分钟计）

保养

使用自动清洗 · 充电装置清洁

► 准备自动清洗 · 充电装置

从自动清洗 · 充电装置上拔出剃须刀和电器插头。

1 取下蓄水盒，并打开蓄水盒盖。

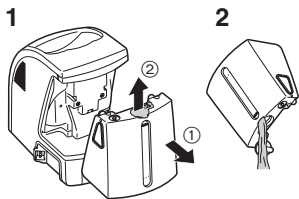

2 倒掉剩余的清洁液，并冲洗蓄水盒。

3 倒入自来水至注水线。

• 不要让自来水超过注水线。这可能会导致清洁液溢出。

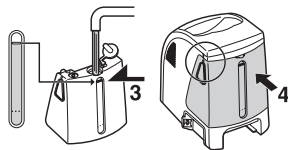

4 盖紧蓄水盒盖并装上蓄水盒。

5 剥去新清洁剂盒上的密封条。(2根)

• 水平握住清洁剂盒。(如果清洁剂盒太倾斜清洁剂会溢出。)

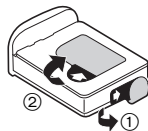

清洁剂盒相关注意事项

- 请勿放在小孩可以接触到的地方。
- 只能用于清洁电动剃须刀的刀头。
- 如果清洁剂进入口中或眼睛，请立即采取紧急措施，并咨询医生。

6 装上清洁剂盒。

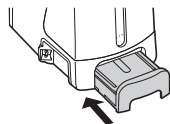

- 当状态灯亮时更换清洁剂盒。
- 清洁液开启后有效期为 6 个月。如果清洁液超过 6 个月未使用，请扔掉清洁剂盒以及清洁液并购买新的装入使用。
- 仅使用专为 Panasonic 剃须刀配制的清洁剂。
- 必须同时更换清洁剂盒以及蓄水盒里的清洁液。加水，或只换清洁剂盒或水，将导致清洁功能变差。
- 启动自动清洗 · 充电装置，清洁剂盒里浓缩的清洁剂将会注入蓄水盒内和水稀释，这样蓄水盒里的水就变成了清洁液。

清洗剃须刀

- 1 将充电器电源线插头与自动清洗 · 充电装置连接。**
- 2 将充电器接通电源。**
- 3 取下保护盖，然后装上剃须刀。**

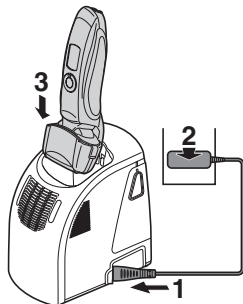







- 若用洗手液或任何其他清洁剂洗过剃须刀，请清除剃须刀上残留的任何洗手液或水渍。
- 装载前请关闭剃须刀电源。
- 装剃须刀时请确认外刀网是否变形或损坏。

4 按下选择按钮选择程序。

- 每次按下选择按钮，程序会从“清洁 / 干燥 / 充电”→“干燥 / 充电”→“充电”依次更改。
- 程序被选择约 6 秒钟后启动。
- 如果关闭电源，程序将自动中止。这种情况下请再次重新启动程序。
- 为避免清洁液溢出导致故障发生请不要拆开清洁剂盒或蓄水盒。

COURSE
SELECT

进程	需要时间 (参考值)
① 充电 	充电 0 到 60 分钟 

进程	需要时间 (参考值)						
② 清洁 / 干燥 / 充电 	<table border="0"> <tr> <td>清洁</td> <td>干燥</td> <td>充电</td> </tr> <tr> <td>10 分钟</td> <td>50 分钟 (80 分钟*)</td> <td>0 到 60 分钟</td> </tr> </table>    <p>• “清洁 / 干燥 / 充电”程序启动后无法切换程序。</p>	清洁	干燥	充电	10 分钟	50 分钟 (80 分钟*)	0 到 60 分钟
清洁	干燥	充电					
10 分钟	50 分钟 (80 分钟*)	0 到 60 分钟					
③ 干燥 / 充电 	<table border="0"> <tr> <td>干燥</td> <td>充电</td> </tr> <tr> <td>100 分钟</td> <td>0 到 60 分钟</td> </tr> </table>   <p>• 即使“干燥 / 充电”程序启动后仍可切换到“清洁 / 干燥 / 充电”程序。</p>	干燥	充电	100 分钟	0 到 60 分钟		
干燥	充电						
100 分钟	0 到 60 分钟						

* 自动清洗 • 充电装置的环境温度过低 (约 15°C 或更低) 时

- 在极低温（约 0°C 或更低）下清洁或干燥功能可能停止运作。在这种情况下，若选择“清洁 / 干燥 / 充电”程序，清洁灯 (CLEAN) 和干燥灯 (DRY) 将会闪烁。若选择“干燥 / 充电”程序，干燥灯 (DRY) 将会闪烁。

▶ 若状态灯闪烁或发亮，请进行以下步骤。

闪烁

正确放置清洁剂盒，然后重新启动。



如果状态灯熄灭

继续下一个程序。

亮起

从自动清洗 · 充电装置上取下剃须刀后，确认 [CLEAN] 灯已经熄灭。（小心刀片可能烫手或潮湿。）确认蓄水盒是否正确装上，蓄水盒盖是否盖紧，自动清洗 · 充电装置是否水平放置。



发现异常并更正后

从自动清洗 · 充电装置上取下充电器并重新装上，然后重新启动程序。



当无异常发现时

需要更换蓄水盒内部的清洁剂盒和清洁液。清洗原来的清洁液，然后冲洗蓄水盒并用水盛满。更换原来的清洁剂盒并重新启动程序。



当状态灯熄灭时

继续下一个程序。



当状态灯再次变亮时

联系授权的维修中心。

不使用自动清洗 · 充电装置清洁剃须刀

1. 将剃须刀上的充电器电源线插头拔出。
2. 在外刀网上涂抹少量洗手液和水。
3. 旋转锁环，启动电源开关。
4. 按下电源开关 2 秒钟以上以启动声波洗净模式。
 - 电池电量指示灯依次闪烁。
 - 约 20 秒钟后，电源自动关闭，或者按电源开关可关闭电源。
5. 取出外刀部，按下电源开关 2 秒钟以上启动声波洗净模式进行声波振动清洗。使用流动水来清洁。
6. 用干布拭去水珠。
7. 将外刀部和剃须刀完全擦干。
8. 将外刀部安装至剃须刀上。
9. 给剃须刀上润滑油。

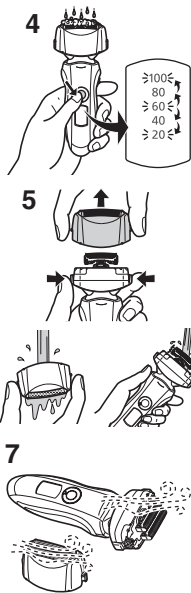

左侧符号表示适合用在打开的水龙头下进行清洗。

警告

用水清洗剃须刀前，请将剃须刀与电源线分离，以防触电。

使用自动清洗 · 充电装置干燥剃须刀

1. 将外刀部安装至剃须刀上。
2. 使用“干燥 / 充电”程序的自动清洗 · 充电装置烘干剃须刀。
3. 给剃须刀上润滑油。

润滑

为长期保持剃须的舒适度，建议使用附赠的润滑油。

1. 关闭剃须刀电源。
2. 给每个外刀网滴一滴润滑油。
3. 推起修剪刀并滴一滴润滑油。
4. 启动剃须刀电源，运转约 5 秒钟。
5. 关闭剃须刀电源，使用软布将外刀网上多余的润滑油拭去。



- 如使用自动清洗 • 充电装置的话则无需给刀片涂润滑油（清洁剂中含有润滑剂）。

使用清洁刷清洁

使用短刷，沿左图所示 (A) 的移动方向移动，清洁内刀头。
使用长刷，清洁外刀网、剃须刀机身和修剪刀。

- 请勿沿 (B) 方向移动短刷，因为这样将损坏内刀头而影响刀片的锋利度。
- 请勿使用短刷清洁外刀网。

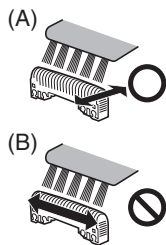

更换外刀网和内刀头

为了维持剃须刀的剃须性能，建议外刀网每年更换一次，内刀头每两年更换一次。

► 更换外刀网

1. 按下外刀架释放按钮并向上提起取出外刃部。
2. 按下外刀网释放按钮，拉出外刀网。
3. 对齐外刃架 (△) 标识和外刀网 (△) 标识然后稳固地安装在一起。
 - 外刀网不能反向安装。
 - 安装到剃须刀时，请确保外刀网插入到外刃架内。
4. 将外刃架 (△) 标识转到前面以后，把外刃部稳固地安装到剃须刀直至其到位。

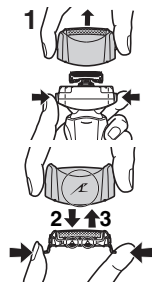

► 更换内刀头

1. 按下外刀架释放按钮并向上提起取出外刀部。
2. 取下内刀头，一次取一个。
 - 不要触摸内刀头的边沿（金属部分），以防止您的手受伤。
3. 安装内刀头时，一次插入一个内刀头，直至固定位置为止。

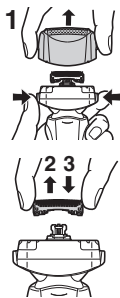

► 更换部件

更换部件在经销商或 Panasonic 认定维修店有售。

ES-LT70 的更换 部件	外刀网	WES9087
	内刀头	WES9068

清洁自动清洗 · 充电装置

修剪下来的胡须屑可能会附着在自动清洗 · 充电装置的托盘里。请按照以下步骤清除胡须屑。建议每次更换清洁剂盒时同时完成此事。

1. 务必从自动清洗 · 充电装置上移除蓄水箱和电器插头。

- 注意不要溢出清洁液。

2. 使用用水蘸湿的布或面巾纸，轻轻拭去任何附着在清洁托盘里的胡须屑。

- 使用蘸水的棉签清洁托盘的四角和不平之处。

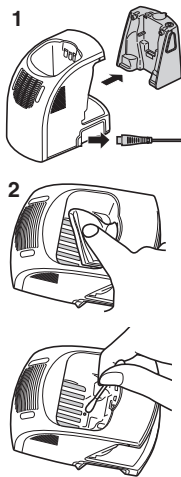

警告

禁止用水洗或将水撒在充电器或自动清洗 · 充电装置上。否则可能会导致触电或短路。

- 不要用力拉清洁托盘底部的刀头橡皮保护套。如果用力拉橡皮会脱落。只需轻轻向上提即可。

▶ **当水没有从清洁托盘里排出时**
修剪下来的胡须屑可能会堵塞清洁托盘底部的排水口。
在这种情况下，您将无法使用清洁或干燥功能。
请使用牙签将修剪下来的胡须屑推向排水口。

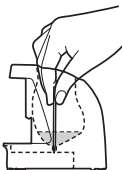

内置式充电电池的取出方式

本产品内藏有充电电池，在消费者决定废弃本产品前，请务必将电池从本产品中取出。

- 分解本产品，取出电池前，一定要关闭电源。鼓励消费者在决定废弃本产品前，事先征求经销商或 Panasonic 认定维修店的意见，尽量延长本产品的使用寿命。
- 当消费者决定废弃本产品又不想自行分解本产品取出电池时，鼓励消费者将本产品送往 Panasonic 认定维修店，由维修店对电池进行分解和回收。
- 电池务必废弃于政府规定的地方或回收处理单位。

- 按下图所示的 ① ~ ④ 的顺序拆开本产品，卸下电池。

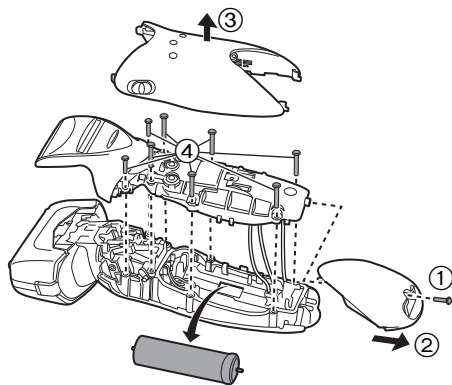

环境保护与资源回收

此剃须刀使用锂电池。

如果您的国家有相关规定，请务必在指定处对旧电池进行统一处理。

规格

产品名称	电动剃须刀	
产品型号	ES-LT70	
充电器额定输入	100-240V~ 50-60Hz 180mA	
充电器额定输出	5.4V--- 1.2A	
马达电压	3.6V---	
充电时间	约 1 小时	
原产地	本机：日本 充电器：中国 自动清洗·充电装置：中国	
生产日期	请见商品上刻印	
执行标准	中国国家标准	GB4706.1 附录 B GB4706.9

本产品仅适合家庭使用。

**Thank you for choosing a Panasonic shaver.
Please read all instructions before use.**

Important

This shaver has a built-in rechargeable battery. Do not throw into fire, apply heat, or charge, use, or leave in a high temperature environment.

► Using the shaver

Caution

The outer foil is very thin and can be damaged if not used correctly. Check that the foil is not damaged before using the shaver. Do not use the shaver if the foil etc. is damaged as you will cut your skin.

- Terminate the usage when there is abnormality or failure.
- Do not shave with soap or clean it with water when operating with the adaptor.
- Do not share with your family or other people.
- This appliance is not intended for use by persons (including children) with reduced physical, sensory or mental capabilities, or lack of experience and knowledge, unless they have been given supervision or instruction concerning use of the appliance by a person responsible for their safety. Children should be supervised to ensure that they do not play with the appliance.

- Persons using an implanted medical electronic device, such as a pacemaker, should not allow this unit to touch the skin where the medical electronic device is implanted because this may cause a malfunction.

► Charging the shaver

- Never use the adaptor in the bathroom or shower room.
- Do not use any power cord or adaptor other than this adaptor (RE7-51).
- Plug in the adaptor into a household outlet where there is no moisture and handle it with dry hands.
- Hold the adaptor when disconnecting it from the household outlet. If you tug on the power cord, you may damage it.
- The supply cord cannot be replaced. If the cord is damaged, the adaptor should be scrapped.

► Cleaning the shaver

Warning

Disconnect the power cord from the shaver before cleaning it in water to prevent electric shock.

- Keep both the inner blades inserted. If only one of the inner blades is inserted, the shaver may be damaged.
- If you clean the shaver with water, do not use salt water or hot water. Do not soak the shaver in water for a long period of time.

- Clean the housing only with a soft cloth slightly dampened with tap water or soapy tap water. Do not use thinner, benzine, alcohol or other chemicals.

► **Storing the shaver**

- Store the shaver in a place with low humidity after use.
- Do not store the shaver where it will be exposed to direct sunlight or other heat sources.
- Disconnect the power cord when storing the shaver. Do not bend the power cord or wrap it around the shaver.
- Please properly store or dispose the plastic bag of the appliance to avoid any accidents, such as infants suffocation, etc. Keep the plastic bag away from infants. Keep the oil away from children.

► **Self-cleaning recharger**

- Do not clean the adaptor or the self-cleaning recharger in water as it will damage them or cause an electric shock.
- Do not remove the shaver from the self-cleaning recharger while using a course that includes the “Dry” function. A heater is used so the area around the blades becomes extremely hot and you may burn yourself.
- Place the self-cleaning recharger on a level and stable surface. Otherwise the cleaning liquid may spill and discolor leather products or other surfaces. Wipe it immediately.

- The self-cleaning recharger cleans the inner blades and the system outer foil. Brush or wash with water to remove beard trimmings in other areas.
- Use the self-cleaning recharger in temperatures between 15 °C and 35 °C. Otherwise, the following problems may occur.
 - The self-cleaning recharger stops functioning.
 - The lifespan of the rechargeable battery shortens. (Only when you use the self-cleaning recharger in lower temperatures.)
- Use the self-cleaning recharger in humidity less than 95%.
- Depending on the environment, the shaver may not dry even if you select the “Dry/Charge” course. In this case, wipe off any drops of water with a dry cloth.

Parts identification

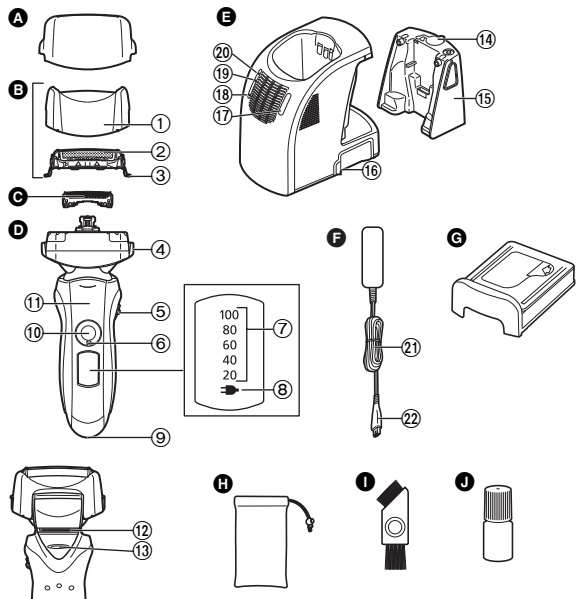

- A** Protective cap
B Outer foil section
 ① Foil frame
 ② System outer foil
 ③ System outer foil release buttons
- C** Inner blades
D Main body
 ④ Foil frame release buttons
 ⑤ Pivot action selector
 ⑥ Lock ring

- ⑦ Battery capacity lamp
 ⑧ Charge status lamp (→)
 ⑨ Appliance socket
 ⑩ Power switch [0/1]
 ⑪ Finger rest
 ⑫ Trimmer
 ⑬ Trimmer handle
- E** Self-cleaning recharger
 ⑭ Water tank cap
 ⑮ Water tank
- ⑯ Socket
 ⑰ SELECT button
 ⑱ STATUS lamp
 ⑲ DRY lamp
 ⑳ CLEAN lamp
- F** Adaptor (RE7-51)
 ㉑ Power cord
 ㉒ Appliance plug
- G** Detergent cartridge
H Travel pouch
I Cleaning brush
J Oil

Using the lock ring

Use the lock ring to lock or unlock the power switch.
 1. Rotate the lock ring until it clicks.



Unlock the power switch:

For when shaving, washing the shaver, lubricating the shaver.



Lock the power switch:

For when carrying the shaver.

Charge

Charging with the self-cleaning recharger

Thoroughly wipe off any drops of water on or around the self-cleaning recharger so that it is dry before charging it.

- 1 Insert the appliance plug into the self-cleaning recharger.**
- 2 Plug in the adaptor.**
- 3 Remove the protective cap and then attach the shaver.**

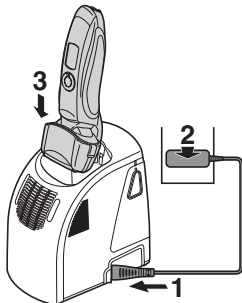

- The “Charge” course starts when attaching the shaver.
- Turn the shaver off before attaching.
- Check that the outer foil is not deformed or damaged when you are attaching the shaver.
- You can charge even with the STATUS lamp of the self-cleaning recharger blinking.
- Charging is completed after approx. 1 hour.

You can keep the shaver attached to the self-cleaning recharger, or connected to the adaptor, when not using it to maintain full battery capacity. You cannot overcharge the shaver.

Charging without the self-cleaning recharger

You can also charge without the self-cleaning recharger.

- 1 Insert the appliance plug into the shaver.**
- 2 Plug in the adaptor into a household outlet.**

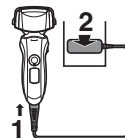

Cord shaving

If you insert the appliance plug to the shaver and plug in the adaptor into a household outlet, you can use it even if the battery capacity is low.

- If the shaver does not work, continue charging it for approx. 1 minute.

Reading lamps when charging

While charging

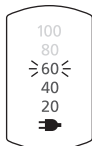

The charge status lamp (➡) glows.

The number of the battery capacity lamp will increase as charging progresses.

After charging is completed

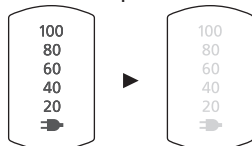

All the battery capacity lamps will light up and then turn off after 5 seconds.

- Recommended ambient temperature for charging is 15-35 °C. The battery may degrade the performance or may not charge under extreme low or high temperatures. The charge status lamp (➡) will blink when there is a problem with charging.
- When charging the shaver for the first time or when it has not been in use for more than 6 months, the charge status lamp (➡) may not glow. It will eventually glow if kept connected.

Shave

Using the shaver

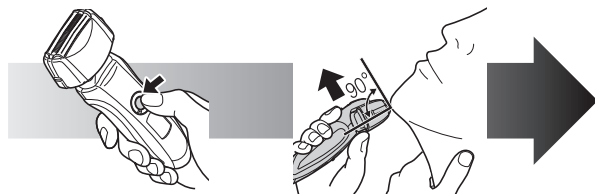

- 1 Rotate the lock ring and press the power switch.**
- 2 Hold the shaver as illustrated above and shave.**

Page 19

Start out shaving by applying gentle pressure to your face. Stretch your skin with your free hand and move the shaver back and forth in the direction of your beard. You may gently increase the amount of pressure as your skin becomes accustomed to this shaver. Applying excessive pressure does not provide a closer shave.

Caution

- If you press the power switch for more than 2 seconds, the sonic vibration cleaning mode is activated. **Page 26**
You cannot shave in this mode.
- Do not place your fingers on the power switch while using the shaver. This may cause the shaver to turn off or enter the sonic vibration cleaning mode. Place your fingers on the finger rest while using the shaver.

Pivot action selector

Use to select "SOFT" (soft) or "LOCK" (lock).

You can change the pivot action whether the shaver is turned on or off.

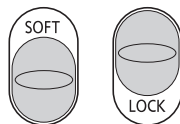

Using the trimmer

Slide the trimmer handle up. Place at a right angle to your skin and move downwards to trim your sideburns.



Reading lamps when using

While using

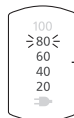

- Approximate amount of battery charge is displayed as 20 - 100 (%).

- The charge status lamp (→) glows when using cord shaving.
- It will turn off approximately 5 seconds after operating the switch.

When the battery capacity is low

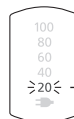

- "20%" blinks when operating the shaver.

- You can shave 2 to 3 times after "20%" appears. (This will differ depending on usage.)
- A full charge will supply enough power for approx. 14 shaves of 3 minutes each.

Care

Cleaning with the self-cleaning recharger

► Preparing the self-cleaning recharger

Remove the shaver and the appliance plug from the self-cleaning recharger.

- 1** Remove the water tank and then open the water tank cap.

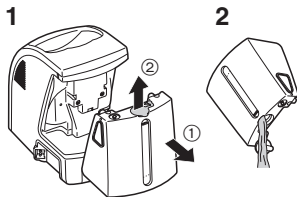

- 2** Wash away the old cleaning liquid and then rinse the water tank.

- 3** Pour tap water into the water tank.

- Do not let the water rise above the maximum water line. This may cause the cleaning liquid to spill.

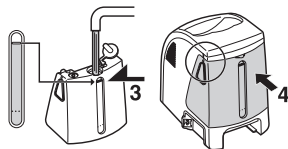

- 4** Securely close the water tank cap and then attach the tank.

- 5** Peel off the seals from the new detergent cartridge. (2 seals)

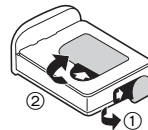

- Hold the detergent cartridge horizontally. (The detergent may spill if the detergent cartridge is tilted too much.)

Precautions for the detergent cartridge

- Keep out of reach of children.
- Only use to clean the blades of electric shavers.
- Carry out emergency measures if the Cleaning agent enters mouth or eyes, and consult a doctor.

- 6** Attach the detergent cartridge.

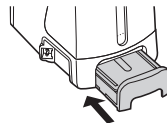

- Replace the detergent cartridge when the status lamp is illuminated.
- The expiration date of the cleaning liquid is 6 months after it is opened. If you do not use the cleaning liquid for more than 6 months, throw away the detergent cartridge and the cleaning liquid.
- Only use self-cleaning recharger detergent for Panasonic shavers.
- Always change the detergent cartridge and the cleaning liquid in the water tank at the same time. Adding water, or changing just the detergent cartridge or the water, will result in deteriorated cleaning functions.
- If you operate the self-cleaning recharger, the concentrated detergent in the detergent cartridge dilutes and the water inside the tank will become a cleaning liquid.

Cleaning the shaver

- 1** Insert the appliance plug into the self-cleaning recharger.
- 2** Plug in the adaptor.
- 3** Remove the protective cap and then attach the shaver.

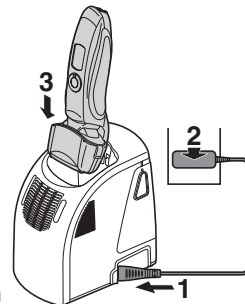

- Remove any soap or water on the shaver if it has been washed with hand soap or any other detergent.
- Turn the shaver off before attaching.
- Check that the outer foil is not deformed or damaged when you are attaching the shaver.









4 Press the SELECT button to select the course.

- Each time you press the SELECT button, the course changes from “Clean/Dry/Charge” → “Dry/Charge” → “Charge”.
- The courses start approximately 6 seconds after they are selected.
- The course will be aborted if the power is cut off. In this case, perform the course again from the beginning.
- Do not detach the detergent cartridge or the water tank as the cleaning liquid may spill causing a malfunction.



Course	Time required (guide)
1 Charge 	Charge 0 to 60 min 

Course	Time required (guide)
2 Clean/ Dry/ Charge  Clean 10 min  Dry 50 min (80 min*)  Charge 0 to 60 min 	<ul style="list-style-type: none"> • It is not possible to change the course after the “Clean/Dry/Charge” course has started.
3 Dry/ Charge  Dry 100 min  Charge 0 to 60 min 	<ul style="list-style-type: none"> • It is possible to change to the “Clean/Dry/Charge” course even after the “Dry/Charge” course has started.

- * When the ambient temperature of the self-cleaning recharger is low (approx. 15 °C or lower)
- The Clean or Dry function may stop under extreme low temperatures (approx. 0 °C or lower). In such a case, the CLEAN and DRY lamps will blink when the “Clean/Dry/Charge” course is selected, or the DRY lamp will blink when the “Dry/Charge” course is selected.

► Follow the steps outlined below if the status lamp blinks or glows.

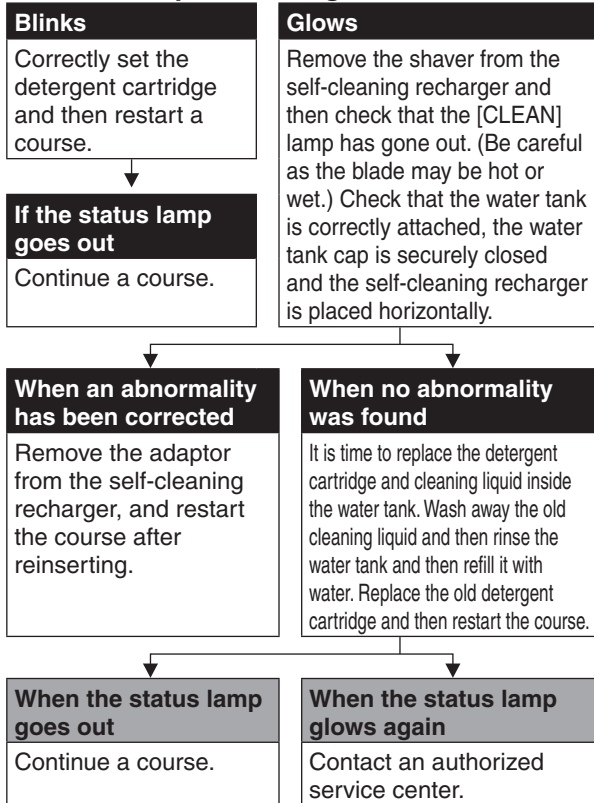

Cleaning the shaver without the self-cleaning recharger

1. Disconnect the power cord from the shaver.
2. Apply some hand soap and some water to the outer foil.
3. Rotate the lock ring to unlock the power switch.
4. Press the power switch for more than 2 seconds to activate the sonic vibration cleaning mode.
 - The battery capacity lamps blink in order.
 - After about 20 seconds, it will be automatically turned off, or you can turn it off by pressing the power switch.
5. Remove the outer foil section and press the power switch for more than 2 seconds to activate the sonic vibration cleaning mode and clean it with running water.
6. Wipe off any drops of water with a dry cloth.
7. Dry the outer foil section and the shaver completely.
8. Attach the outer foil section to the shaver.
9. Lubricate the shaver.

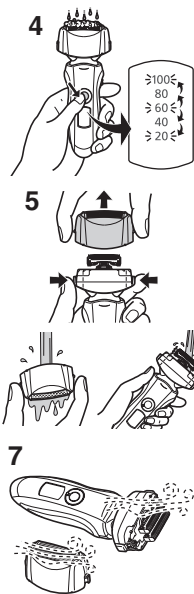



The mark on the left means suitable for cleaning under an open water tap.

Warning

Disconnect the power cord from the shaver before cleaning it in water to prevent electric shock.

Drying the shaver with the self-cleaning recharger

1. Attach the outer foil section to the shaver.
2. Dry the shaver with self-cleaning recharger using "Dry/Charge" course.
3. Lubricate the shaver.

Lubrication

To maintain shaving comfort for a long time, it is recommended that the oil provided with the shaver is used.

1. Switch off the shaver.
2. Apply one drop of oil to each of the outer foils.
3. Raise the trimmer and apply a drop of oil.
4. Switch the shaver on, and run it for approximately five seconds.
5. Switch off the shaver, and wipe off any excess oil from the outer foils with a soft cloth.

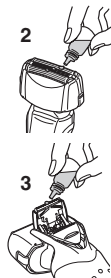

- It is not necessary to oil the blades after cleaning the shaver with the self-cleaning recharger. (Lubricant is included in the cleaning detergent.)

Cleaning with the brush

Clean the inner blades using the short brush by moving it in direction (A). Clean the system outer foil, the shaver body and the trimmer using the long brush.

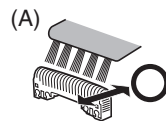

- Do not move the short brush in direction (B) as it will damage the inner blades and affect their sharpness.

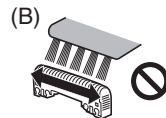

- Do not use the short brush to clean the outer foils.

Replacing the system outer foil and the inner blades

system outer foil	once every year
inner blade	once every two years

► Replacing the system outer foil

1. Press the foil frame release buttons and lift the outer foil section upwards.
2. Press the system outer foil release buttons and pull down the system outer foil.
3. Align the foil frame mark (↙) and the system outer foil mark (△) and securely attach together.
 - The system outer foil cannot be reversely attached.
 - Always insert the system outer foil to the foil frame when attaching to the shaver.
4. After turning the foil frame mark (↙) to the front, securely attach the outer foil section to the shaver until it clicks.



► Replacing the inner blades

1. Press the foil frame release buttons and lift the outer foil section upwards.
2. Remove the inner blades one at a time.
 - Do not touch the edges (metal parts) of the inner blades to prevent injury to your hand.
3. Insert the inner blades one at a time until they click.

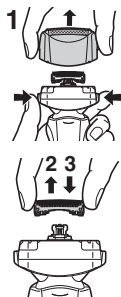

► Replacement parts

Replacement parts are available at your dealer or Service Center.

Replacement parts for ES-LT70	System outer foil	WES9087
	Inner blades	WES9068

Cleaning the self-cleaning recharger

Beard trimmings may become attached to the cleaning tray of the self-cleaning recharger. Follow the steps below to remove them. We recommend doing this each time you change the detergent cartridge.

1. Be sure to remove the water tank and the appliance plug from the self-cleaning recharger.
 - Be careful not to spill the cleaning liquid.
2. Gently wipe off any beard trimmings attached to the inside of the cleaning tray with a cloth or tissue paper dampened with water.
 - Clean the corners and uneven parts of the cleaning tray with a cotton swab dampened with water.

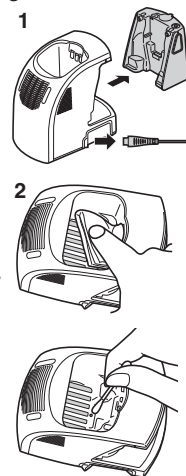

Warning

Do not wash or apply water to the adaptor or self-cleaning recharger. Failure to observe this may cause electric shock or result in short circuits.

- Do not pull hard on the rubber blade protector at the bottom of the cleaning tray. The rubber may come off if you pull hard on it. It is only necessary to pull it up slightly.

► When the water does not drain from the cleaning tray

Beard trimmings may clog the drain at the bottom of the cleaning tray.

In this case, you cannot clean or dry the shaver.

Push the beard trimmings down through the drain with a tooth pick etc.

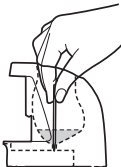

Removing the built-in rechargeable battery

Remove the built-in rechargeable battery before disposing of the shaver. Please make sure that the battery is disposed of at an officially designated location if there is one. Do not dismantle or replace the battery so that you can use the shaver again. This could cause fire or an electric shock. Replace it at an authorized service center.

- Disconnect the power cord from the shaver when removing the battery.
- Perform steps ① to ④ and lift the battery, and then remove it.

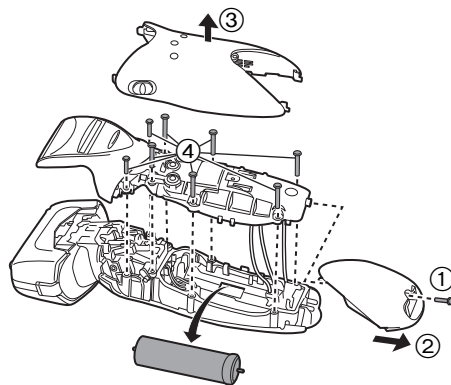

For environmental protection and recycling of materials

This shaver contains a Lithium-ion battery. Please make sure that the battery is disposed of at an officially assigned location, if there is one in your country.

Specifications

Product name	AC/Rechargeable Shaver	
Product model	ES-LT70	
Rated input	100-240V~ 50-60Hz 180mA	
Rated output	5.4V $\overline{\text{---}}$ 1.2A	
Motor voltage	3.6V $\overline{\text{---}}$	
Charging time	Approx. 1 hour	
Place of origin	Main body: Japan Adaptor: China Self-cleaning recharger: China	
Date of production	See engraving on the commodity.	
Execution standard	Chinese standard	GB4706.1 appendix B GB4706.9

This product is intended for household use only.

进口商：松下电工（中国）有限公司
地址：北京市朝阳区建国路79号 华贸中心2号写字楼6层、7层703室
电话：86-10-59255988
邮政编码：100025

制造商：松下电工株式会社
地址：日本大阪府门真市大字门真1048番地

Panasonic Electric Works Co., Ltd.
1048, Oaza Kadoma, Kadoma-shi, Osaka 571-8686, Japan

日本印刷
Printed in Japan
ES9700LT701K Y0510-0
发行：2010年5月