

# Panasonic®

## 使用说明书 Operating Instructions

### (家用) 电动剃须刀 (Household) AC/Rechargeable Shaver

型号 ES-RL40  
Model No.

中文	2
English	7



在使用本产品前，请仔细阅读本说明书并妥善保管，以备将来参考。

Before operating this unit, please read these instructions completely and save them for future use.

## 重要事项

### ► 使用剃须刀

#### 注意

因外刀网很薄，若使用不当就可能造成损坏。使用剃须刀前，请确认外刀网是否损坏。如果外刀网已损坏，请不要使用该剃须刀，因为这样会割伤皮肤。请勿用于修剪宠物的毛发。

### ► 充电

- 请不要使用除 RE7-58 充电器以外的任何电源线或充电器进行充电。
- 将充电器插入家用电源插座内进行充电，操作时双手应保持干燥。
- 剃须刀在使用和充电过程中可能会变热，但这不是故障。
- 不要将剃须刀放置在阳光直射或有其他热源的地方进行充电。
- 从家用电源插座上拔出充电器时，不要用力拉电源线，因为可能会损坏电源线，应抓紧充电器的插头部位。
- 电源线不能更换，如果电源线损坏，此充电器应废弃。
- 充电的最佳环境温度为 0 至 35 摄氏度。

### ► 清洁剃须刀

#### 警告

用水清洗剃须刀前，请将剃须刀与电源线分离，以防触电。

- 请在装有两个内刀头的状态下进行清洗，若在仅装有一个内刀头的状态下进行清洗，可能会损坏剃须刀。

- 可用清水清洗剃须刀，不要使用盐水或热水。不要将剃须刀长时间浸泡在水中。可用蘸肥皂水的布擦拭剃须刀。不要使用稀释剂，汽油或酒精擦拭剃须刀任何部位。

### ► 存放剃须刀

- 存放剃须刀时请拔出电源线。不要折弯电源线或将电源线缠绕在剃须刀上。
- 本品不宜供肢体、感官或精神上有残疾者、或缺乏经验和知识者（包括儿童）使用，必须有监护者从旁监督并对本品的使用加以指导，且对使用者的安全能承担责任。请避免儿童将本品视为玩具，从而引发危险。
- 请妥善处理本产品的包装袋，避免婴幼儿窒息等意外发生。请置于儿童触摸不到的地方。
- 请妥善保管本说明书。

## 各部分名称

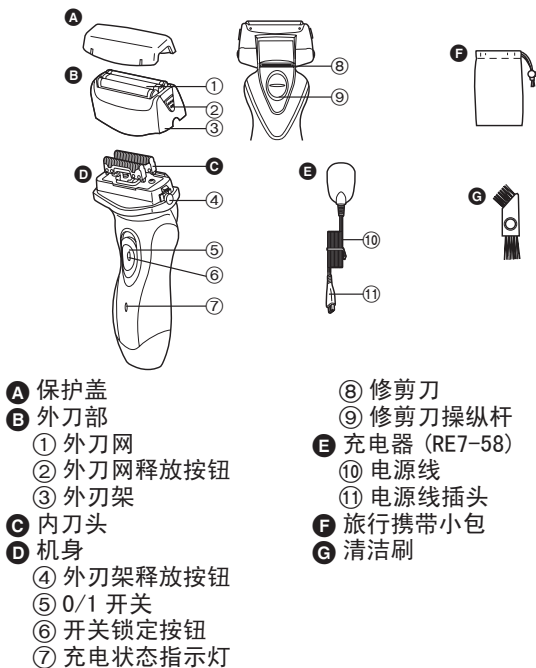

## 充电

### 为剃须刀充电

如果感觉剃须刀速度下降, 请按下列步骤给剃须刀充电。此剃须刀完全充电时间为 1 小时。  
• 充足电后大约可提供 14 次剃须所需的电量。(以一次剃须 3 分钟计)

- 1 将充电器电源线插头与剃须刀连接。
- 2 将充电器插头插入家用电源插座里。

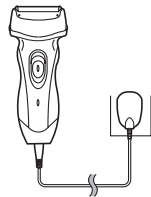

• 购买后初次使用或半年以上未使用过, 请充电 8 小时(要激活充电电池活性) 如果充电电池完全放电后充电, 充电指示灯可能不会立即亮, 继续充电几分钟后即正常。

### 利用交流电剃须

当电池电量低时, 您可将剃须刀通过充电器连接至家用电源插座, 利用交流电进行剃须。

• 如果剃须刀不能正常使用, 请充电约 1 分钟后使用。

### 关于指示灯

充电时



红灯亮。

充电完成后



指示灯每秒闪烁一次。

## 剃须

## 使用剃须刀



**1** 按下开关锁定按钮并将 0/1 开关向上推动。

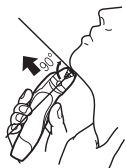

**2** 如上图所示握住剃须刀剃须。

轻轻地压向面部开始剃须。用另一只手绷紧脸上皮肤，逆着胡须生长方向前后移动剃须刀。当皮肤适应剃须刀之后您可以稍稍加大压力，但施加压力过大就会造成皮肤伤害。

## 使用修剪刀

将修剪刀操纵杆往上推，以打开修剪刀。将修剪刀放置与皮肤成直角（90度）的位置，然后从上向下移动进行修剪。



## 注意

在外刃架与外刀网未装上的情况下，切勿使用修剪刀。有造成伤害可能性。

## 清洁

## 清洁剃须刀

1. 将剃须刀上的充电器电源线插头拔出。
2. 在外刀网上涂抹少量洗手液和水。
3. 启动剃须刀并向外刀网撒些水。
4. 10 至 20 秒后关闭剃须刀。
5. 取出外刀部并打开剃须刀。
6. 用流动的水清洁剃须刀和外刀部。
7. 用干布拭去水珠。

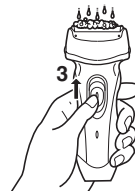

5

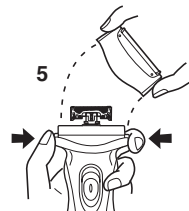

6



8. 将外刀部和剃须刀完全擦干。
9. 将外刀部安装至剃须刀上。



左侧符号表示适合用在打开的水龙头下进行清洗。

### 警告

用水清洗剃须刀前，请将剃须刀与电源线分离，以防触电。

## 更换外刀网和内刀头

为了维持剃须刀的剃须性能，建议外刀网每年更换一次，内刀头每两年更换一次。

### ► 更换外刀网

1. 如图所示，按下外刀网释放按钮并向上提起取出外刀网。
2. 向下插入外刀网直至固定位置为止以装上外刀网。

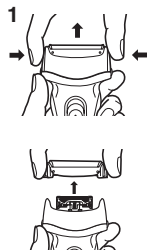

### ► 更换内刀头

1. 如图所示，按下外刀架释放按钮并向上提起，取出外刀部。
2. 如图所示，取下内刀头，一次取一个。
  - 不要触摸内刀头的边沿（金属部分），以防止您的手受伤。
3. 如图所示，安装内刀头时，每次插入一只内刀头，直至固定位置为止。

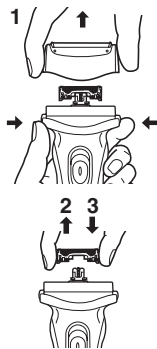

## 使用刷子清洁

使用短刷，沿左图所示 (A) 的移动方向移动，清洁内刀头。使用长刷，清洁外刀网、剃须刀机身和修剪刀。

- 请勿沿 (B) 方向移动短刷，因为这样将损坏内刀头而影响刀片的锋利度。
- 请勿使用短刷清洁外刀网。

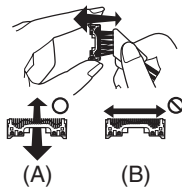

## 内置式充电电池的取出方式

中文

剃须刀内藏可充电的电池，在消费者决定废弃剃须刀前，请务必将电池从剃须刀中取出。

- 分解剃须刀，取出电池前，一定要先断开电源。
- 鼓励消费者在决定废弃剃须刀时，事先征求经销商或本公司指定维修点的意见，尽可能延长剃须刀的使用寿命。
- 当消费者决定废弃剃须刀又不想自行分解剃须刀取出电池时，鼓励消费者将器具送往本公司指定的维修站，由维修店对电池进行分解和回收。
- 电池务必废弃于政府规定的地方或回收处理单位。
- 按下图所示的①～⑦的顺序拆开本体，卸下电池。

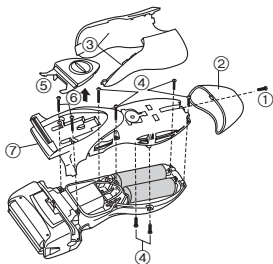

### 环境保护与资源回收

此剃须刀含二枚镍氢电池。  
如果贵国有相关规定，请务必在指定处对旧电池进行统一处理。

## 规格

产品名称	电动剃须刀	
产品型号	ES-RL40	
充电器额定输入	100-240V~ 110mA 50-60Hz	
充电器额定输出	3.6V--- 0.8A	
马达电压	2.4V---	
充电时间	约 1 小时	
原产地	中国	
生产日期	请见商品上刻印	
执行标准	中国国家标准	GB4706.1 附录 B、GB4706.9
	企业标准	Q/SXDGWB 6

规格如有变更，恕不另行通知。  
本产品仅适合家庭使用。

## Important

### ► Using the shaver

#### Caution

The outer foil is very thin and can be damaged if not used correctly. Check that the foil is not damaged before using the shaver. Do not use the shaver if the foil etc. is damaged as you will cut your skin.

### ► Charging the shaver

- Do not use any power cord or AC adaptor other than this adaptor (RE7-58).
- Plug in the adaptor into a household outlet where there is no moisture and handle it with dry hands.
- The shaver may become warm during use and charging. However, this is not a malfunction.
- Do not charge the shaver where it will be exposed to direct sunlight or other heat sources.
- Hold the adaptor when disconnecting it from the household outlet. If you tug on the power cord, you may damage it.
- The supply cord cannot be replaced. If the cord is damaged, the appliance should be scrapped.
- Adequate ambient temperature for charging is 0-35 °C.

### ► Cleaning the shaver

#### Warning

Disconnect the power cord from the shaver before cleaning it in water to prevent electric shock.

- Keep both the inner blades inserted. If only one of the inner blades is inserted, the shaver may be damaged.
- If you clean the shaver with water, do not use salt water or hot water. Do not soak the shaver in water for a long period of time. Wipe it with a cloth dampened with soapy water. Do not use thinner, benzine or alcohol.

### ► Storing the shaver

- Disconnect the power cord when storing the shaver. Do not bend the power cord or wrap it around the shaver.
- This appliance is not intended for use by persons (including children) with reduced physical, sensory or mental capabilities, or lack of experience and knowledge, unless they have been given supervision or instruction concerning use of the appliance by a person responsible for their safety. Children should be supervised to ensure that they do not play with the appliance.
- Please properly store or dispose the plastic bag of the appliance to avoid any accidents, such as infants suffocation, etc. Keep the plastic bag away from infants.
- Keep these operating instructions in a safe place.

## Parts identification

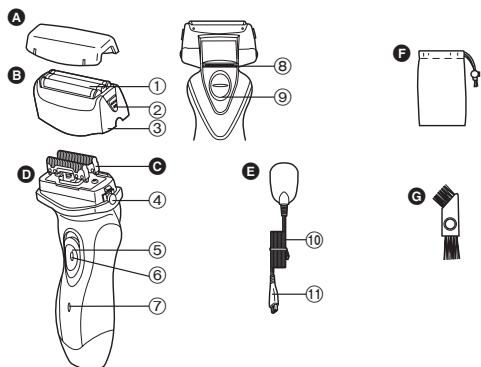

- A** Protective cap
- B** Outer foil section
  - ① System outer foil
  - ② System outer foil release buttons
  - ③ Foil frame
- C** Inner blades
- D** Main body
  - ④ Foil frame release buttons
  - ⑤ O/1 switch
- ⑥ Switch lock button
- ⑦ Charge indicator lamp
- ⑧ Trimmer
- ⑨ Trimmer handle
- E** Adaptor (RE7-58)
  - ⑩ Power cord
  - ⑪ Appliance plug
- F** Travel pouch
- G** Cleaning brush

## Charge

### Charging the shaver

Perform the following steps to charge the shaver if it seems to lose the speed.

You can fully charge the shaver in 1 hour.

- A full charge will supply enough power for approx. 14 shaves of 3 minutes each.

- 1** Insert the appliance plug into the shaver.
- 2** Plug in the adaptor into a household outlet.

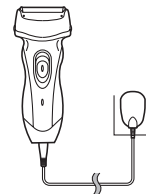

- When charging the shaver for the first time or when it has not been in use for more than 6 months, please charge it for 8 hours (in order to activate the rechargeable battery). If you charge the shaver with the batteries completely discharged, the charge indicator lamp may not glow immediately. However, the lamp will glow normally after charging for a few minutes.

### Cord shaving

If you insert the appliance plug to the shaver and plug in the adaptor into a household outlet, you can use it even if the battery capacity is low.

- If the shaver does not work, continue charging it for approx. 1 minute.



## About the lamp

While charging



Glowes red.

After charging is completed



Blinks once every second.

## Shave

### Using the shaver



**1** Depress the switch lock button and slide the 0/1 switch upwards.

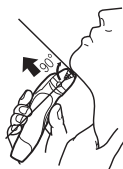

**2** Hold the shaver as illustrated above and shave.

Start out shaving by applying gentle pressure to your face. Stretch your skin with your free hand and move the shaver back and forth in the direction of your beard. You may gently increase the amount of pressure as your skin becomes accustomed to this shaver. Applying excessive pressure does not provide a closer shave.

## Using the trimmer

Slide the trimmer handle up. Place at a right angle to your skin and move downwards to trim your sideburns.



### Caution

Do not use the trimmer without a foil frame and a system outer foil attached. Doing so may result in injury.

## Clean

### Cleaning the shaver

1. Disconnect the power cord from the shaver.
2. Apply some hand soap and some water to the outer foil.
3. Turn the shaver on.
4. Turn the shaver off after 10-20 seconds.
5. Remove the outer foil section and turn the shaver on.
6. Clean the shaver and the outer foil section with running water.
7. Wipe off any drops of water with a dry cloth.

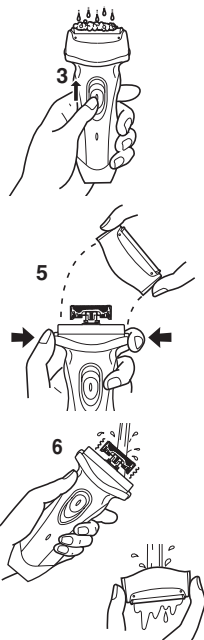

8. Dry the outer foil section and the shaver completely.
9. Attach the outer foil section to the shaver.



The mark on the left means suitable for cleaning under an open water tap.

### Warning

**Disconnect the power cord from the shaver before cleaning it in water to prevent electric shock.**

### Replacing the system outer foil and the inner blades

system outer foil	once every year
inner blade	once every two years

### ▶ Replacing the system outer foil

1. Press the system outer foil release buttons and lift the system outer foil upwards as illustrated.
2. Insert the system outer foil by pushing it downwards until it clicks.

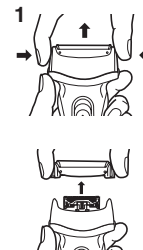

## ► Replacing the inner blades

1. Press the foil frame release buttons and lift the outer foil section upwards as illustrated.
2. Remove the inner blades one at a time as illustrated.
  - Do not touch the edges (metal parts) of the inner blades to prevent injury to your hand.
3. Insert the inner blades one at a time until they click as illustrated.

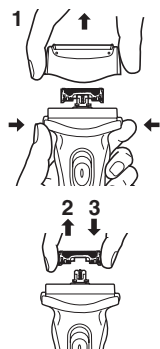

## Cleaning with the brush

Clean the inner blades using the short brush by moving it in direction (A).

Clean the system outer foil, the shaver body and the trimmer using the long brush.

- Do not move the short brush in direction (B) as it will damage the inner blades and affect their sharpness.
- Do not use the short brush to clean the outer foils.

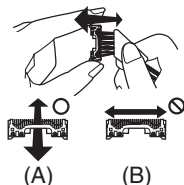

## Removing the built-in rechargeable batteries

Remove the built-in rechargeable batteries before disposing of the shaver. Please make sure that the batteries are disposed of at an officially designated location if there is one. Do not dismantle or replace the batteries so that you can use the shaver again. This could cause fire or an electric shock. Replace them at an authorized service center.

- Disconnect the power cord from the shaver when removing the batteries.
- Perform steps ① to ⑦ and lift the batteries, and then remove them.

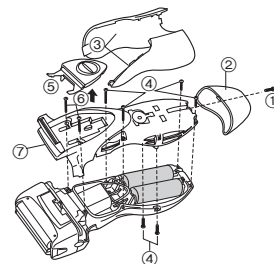

## For environmental protection and recycling of materials

This shaver contains Nickel-Metal Hydride batteries. Please make sure that the batteries are disposed of at an officially assigned location, if there is one in your country.

## SPECIFICATIONS

Product name	AC/Rechargeable Shaver	
Product model	ES-RL40	
Rated input	100-240V~ 110mA 50-60Hz	
Rated output	3.6V=== 0.8A	
Motor voltage	2.4V===	
Charging time	Approx. 1 hour	
Place of origin	China	
Date of production	See engraving on the commodity.	
Execution standard	Chinese standard	GB4706.1 appendix B GB4706.9
	Company standard	Q/ SXDGWB 6

Specifications are subject to change without notice.  
This product is intended for household use only.

Panasonic

# 保修证

## 保修条款

有关保修期内Panasonic商品的保修（无偿修理），从购入之日起开始实施。

1. 保修期内的商品只可在Panasonic认定维修店进行保修；保修时，请出示本保修证及购机发票。  
以下两点需特别注意：

- 本保修证遗失后不再补发，请妥善保管。
  - 本保修证仅限于中华人民共和国内有效（香港、澳门、台湾三地区暂不可使用）。
2. 自购入之日起在以下期间内，在正常使用中发生故障的情况下进行保修。

- 整机（除商用产品）.....2年内无偿
- 整机（商用产品）.....6个月
- 内刀头、外刀网、刀头、辅助装置、附件.....有偿提供

3. 属下列情况之一者，即使在保修期内，也不能以保修对待，但是可以实行收费修理：

- 未按商品使用说明书要求使用、维护、保管而造成损坏的；
- 因不正确操作、电源不正常、破损（如：摔落等）而造成损坏的；
- 不经Panasonic认定维修店维修人员拆卸造成损坏的；
- 不能出示本保修证及有效购机发票的；
- 保修证上记录的信息与商品实物标识不符或者涂改的；
- 因不可抗力因素（如雷电、地震、火灾、水灾等）造成损坏的。

4. 本保修条款只适用于消费者个人为生活消费需要而购买使用的场合，不适用于经营性等使用。

### [商品信息]

商品名称: 电动剃须刀 产地: 中国·广州  
商品型号: ES-RL40 制造编号:

**[保修回执] 以下回执是保修的重要依据，请勿自行撕下**

保修结算 4

商品型号: ES-RL40 制造编号:

保修结算 3

商品型号: ES-RL40 制造编号:

保修结算 2

商品型号: ES-RL40 制造编号:

保修结算 1

商品型号: ES-RL40 制造编号:

促销员留存

商品型号: ES-RL40 制造编号:



保修证管理编码印刷处：

本保修证内容如有变更恕不另行通知

**[销售记录]** 未完整记录以下信息将无法进行保修

销售日期：..... 发票号码：.....

安装调试日期：

销售店  
(盖章)

顾客姓名：..... 联系电话：.....

顾客地址：..... 邮 编：.....

销售店名称：..... 销售店电话：.....

销售店地址：..... 邮 编：.....

**[维修记录]**

维修店名称：..... 联系电话：..... 送修日：.....

维修店地址：..... 邮 编：.....

故障内容：..... 故障原因：.....

维修内容：.....

维修员签字：..... 交验日期：.....

维修店名称：..... 联系电话：..... 送修日：.....

维修店地址：..... 邮 编：.....

故障内容：..... 故障原因：.....

维修内容：.....

维修员签字：..... 交验日期：.....

维修店名称：..... 联系电话：..... 送修日：.....

维修店地址：..... 邮 编：.....

故障内容：..... 故障原因：.....

维修内容：.....

维修员签字：..... 交验日期：.....

Parasonic客户咨询服务中心：

400-810-0781；800-810-0781 (固定电话)

Parasonic官方网站：<http://panasonic.cn>

松下电器(中国)有限公司





**松下电工·万宝电器（广州）有限公司 (PEWWBG)**  
Panasonic Electric Works Wanbao (Guangzhou) Co., Ltd.

工厂地址： 广州市番禺区市广路万宝基地  
(Address): Wanbao Base, Shiguang Road,  
Panyu District, Guangzhou

电话 (Tel): (020)84770333

传真 (Fax): (020)84773033

邮政编码 (Post Code): 511495

原产地： 中国

中国印刷  
Printed in China  
ES0000000000 X0010-0  
发行：2010年0月