

京制00000345号
京药监械(准)字2007第2210453号
YZB/京0059-2007
京药监械生产许20000034号

Panasonic®

电子血压计 Wrist Blood Pressure Monitor

使用说明书 Operating Instructions

型号:EW3038
Model No.EW3038

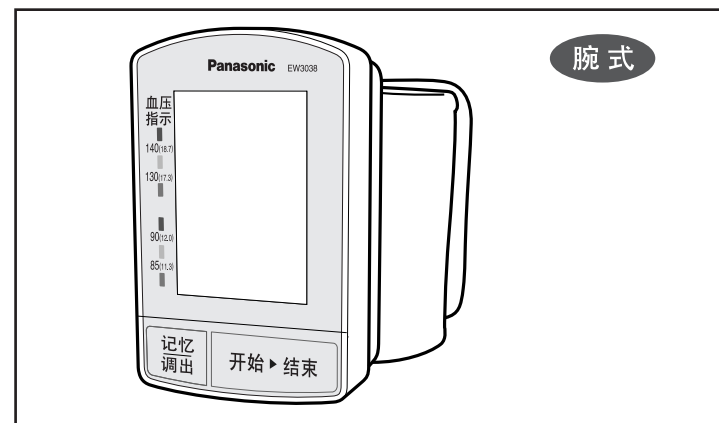

北京松下电工有限公司
Panasonic Electric Works(Beijing)Co.,Ltd
地址:北京经济技术开发区同济北路1号
Add: 1#Tong Ji North Road,Beijing Economic
& Technological Development Zone,Beijing,CHINA
原产地:中国 (Made in China)
邮编: 100176 电话: (010)-67882437
Post: 100176 Tel: (010)-67882437

W9030 3038103
B1107-0
Printed in China

- 感谢您购买本公司产品。
- Thank you for buying our product(s).
- 使用之前请您务必仔细阅读本使用说明书。
- Please read the manual carefully before you use the product for the first time.
- 请您务必妥善保管本使用说明书。
- Please keep the manual in a safe and proper place.

安全注意事项

※使用之前，请仔细阅读本“安全注意事项”，以便正确使用。

※为避免使用者因使用不当而遭受危害或损失，请参阅

“安全注意事项”，正确使用本产品。

为安全起见，请务必遵守本安全注意事项。

 表示注意、警告内容。

 警告：可能导致人的死亡或重伤的内容。

 注意：可能导致人受到伤害以及物质上的损失的内容。

 表示禁止行为。

 表示禁止分解。

 表示B型设备。

 警告	
 务必遵守	●腕部有重度血液循环障碍者，使用前请向医生咨询。 否则有可能引起身体不适。
 注意	
 禁止	●自己判断测量结果而进行治疗十分危险。 ●请将测量结果交给了解您健康状况的医生并接受诊断。 ●如果服用药剂请遵医嘱。 ●对于那些因某些疾病引起的末梢循环障碍者，在手腕和上臂部测量的血压值可能会出现较大差异。
	●请勿用于血压测量以外的用途。 否则将有可能引起事故或发生故障。
 禁止分解	●请勿让婴幼儿和无法表达自我意识的人使用。 否则将有可能引起事故。
	●请勿私自进行拆卸、修理和改造。 否则将有可能发生事故和故障。

※请将本说明书妥善保管。

EW3038型血压计

- 本型号血压计为用于手腕测量的全自动电子血压计，应用示波法，能够快速、简便地测量血压值和脉搏数。
- 本型号血压计适用于人体无创式血压和脉搏的测量。
- 本型号血压计可测量的手腕周长约为12.5cm~22.0cm。

本公司承诺：

保修期内的血压计如发生故障，按照本公司所附《保修证》的规定进行修理。

产品清单

- | | |
|-----------|----|
| ① 主机（含袖带） | 1台 |
| ② 收藏盒 | 1个 |
| ③ 7号碱性电池 | 2节 |
| ④ 使用说明书 | 1本 |
| ⑤ 保修证 | 1张 |
| ⑥ 合格证 | 1张 |
| ⑦ 血压测量记录表 | 1张 |

※随机电池为试机用电池。
是为了在购买时确认商品的功能时使用的。

目录

安全注意事项	1
各部名称	3
准备	4
<ul style="list-style-type: none"> ●测量前的准备 …………… 4 ●卷绑袖带 …………… 5 	
使用方法	6
<ul style="list-style-type: none"> ●正确测量须知 …………… 6.7 ●测量方法……………8~11 ●测量值的记忆和调出 ……………12~13 	
其它	14
<ul style="list-style-type: none"> ●使用结束后…………… 14 ●测量时的注意点…………… 15 ●Q&A ……………16~18 ●防止故障…………… 18 ●发生异常时 …………… 19~20 ●规格 …………… 21 	

各部名称

请确认商品

主机

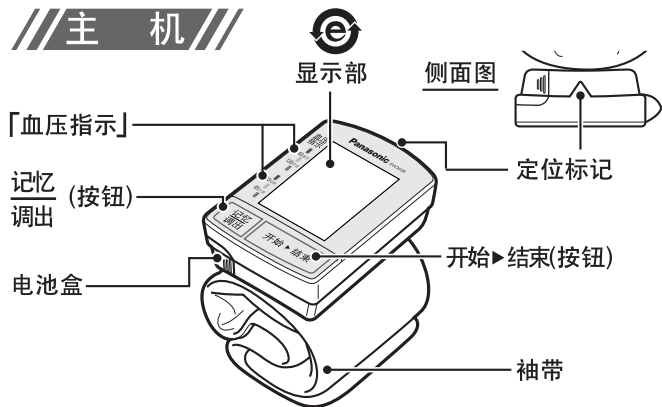

收藏盒

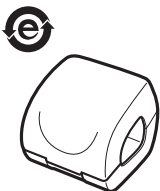

根据需要,有时会在没有事先声明的情况下,改变产品及零部件的规格。

【电池寿命】

- 如果使用一组新的Panasonic碱性电池,约可进行300次测量。
1日测量3次,约可使用3个月(室温23℃、加压至170mmHg(22.7kPa),手腕周长约17.0cm时)
- 如果环境温度较低,则会缩短电池寿命。
- 随机电池用于购买时确认商品的功能,使用寿命可能达不到300次。
- 使用碱性电池以外的电池时,使用次数可能很短,因此请务必使用碱性电池。
- 更换电池时,必须使用同一类型的新电池,2节电池应同时更换。
- 长时间不使用时,请将电池取出。避免因电池漏液而导致主机出现故障。
- 废弃电池请勿乱扔,注意回收。

准备

测量前的准备

※请务必使用碱性电池。

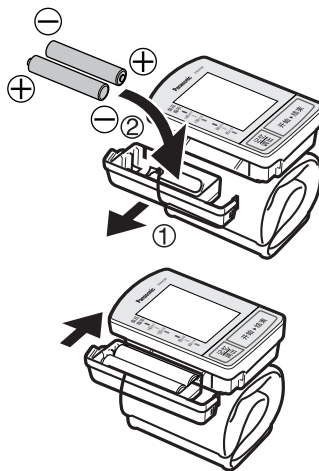

1 装入电池

- ①将电池盒沿箭头方向卸下。
- ②确认电池的 \oplus \ominus 极后,再装入2节7号碱性电池

2 安装电池盒

将电池盒平滑地推入滑道,固定在主机上(直至听见“咔哒”声)

注意



务必遵守

- 务必遵守电池上所表述的注意内容。
- 确认电池的 \oplus \ominus 极后正确地装入。
- 电量不足的电池立即取出。
- 长时间不使用本血压计时,应从血压计中取出电池。
- 请使用有效期内的电池。
如不遵守上述事项可能因电池发热、破裂、漏液而发生伤害或破损。

更换电池

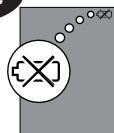

- 测量过程中显示屏出现左图显示时。
- 按下开始▶结束按钮,显示器无任何显示时。

准备

卷绑袖带

将主机的上端贴于腕根处，卷绑袖带。

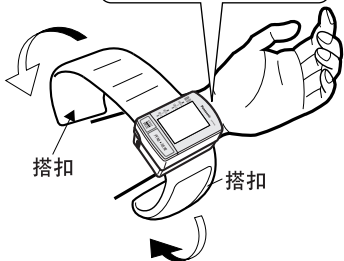

1 将袖带卷绑在手腕内侧

- 卷在裸露的肌肤上
- 可测量的手腕周长约为 12.5cm~22.0cm

2 绑牢袖带

- 如果卷绑松弛，则导致所测的血压值偏高。
- 袖带卷绑时，避免搭扣歪斜、扭曲。

腕根部

卷绑袖带时，应使定位标记与手腕内侧的中央部分相吻合。



- 松开搭扣时，应向正侧面平行揭开，不要拧着强拉硬拽。

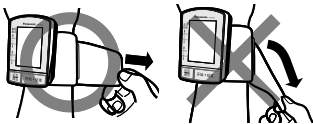

在用右手测量时

请按图示绑卷



左右手任何一侧都可以测量。但是，左右手的血压差值可能约有10mmHg，因此，每次都请用相同侧手腕测量。

使用方法

正确测量须知

每天在同一时间，用同一只手腕、相同姿势进行血压测量

- 请在早晨刚刚醒来，没有尿意时测量；如果不能保证这种状态，请在进早餐前，身体尚未运动时测量。

测量前请务必保持4~5分钟的安静

坐姿测量

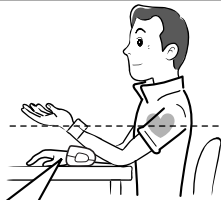

1 将胳膊肘放在桌子上

2 将主机与心脏高度保持一致

保持一致

3 手心向上

身体放松

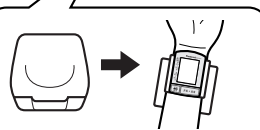

将收藏盒垫在手臂的下面

如用下图所示的手腕形态测量时，不能得出正确的血压值。

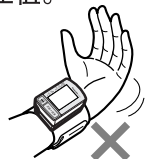

向内侧弯曲



用力握手

使用方法

正确测量须知

主机的位置低于心脏的高度时，所测得的血压值可能偏高。



主机的位置高于心脏的高度时，所测得的血压值可能偏低。



腹部收缩的姿势(前倾的姿势)不能正确的测量。



测量过程中，不得触碰主机。



测量过程中，身体、手腕、手指勿动。



测量过程中，请勿说话。



测量过程中请勿将手机等可发出电磁波的机器靠近主机。否则有可能引起误动作。

使用方法

测量方法

测量时应保持安静，使身体处于自然放松状态。

1 将收藏盒置于被测手腕下面

(为了正确测量，请参照第6,7页)

2 按开始▶结束

- 约2秒钟全显示。
- 自动加压。

因为是在加压时测量，所以在加压过程中动作音、加压速度等会发生变化，这并不是异常现象。

- 如果在加压过程中检测到脉搏时，「♥」符号闪烁。

3 测量结束时，显示血压值及脉搏数

- 袖带内空气自动排出
- 测量结果以mmHg(血压值)、kPa(血压值)交替显示。脉搏数与血压值同时显示。测量值在高血压区域时，数字闪烁(约6秒钟)(血压指示的读法参照第11页)

- 「M」标记显示。

(存储测量值参照第12,13页)

- 测得的脉搏数以1分钟进行换算。

4 关闭电源时，按开始▶结束

- 即使忘记关闭电源，约5分钟后，电源也会自动关闭。

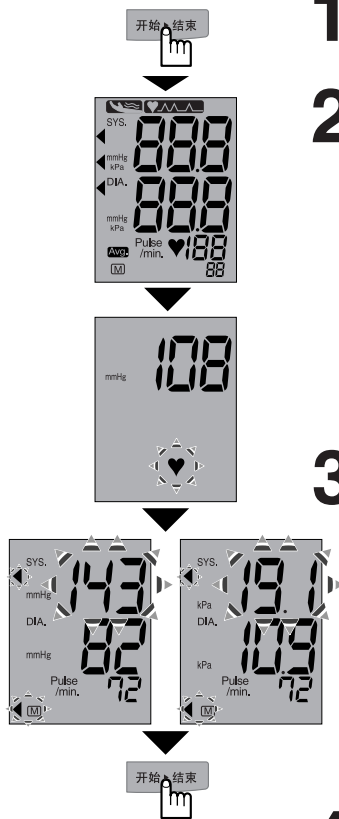

使用方法



测量方法

关于「体动提示」的功能

测量过程中，如果卷绑了袖带的手腕发生无意中弯曲等动作时，有时将不能得到正确的测量值。

- 「体动提示」是指测量过程中，手或手腕等活动向袖带施加了多余的压力时，通过「体动提示」标记提示的功能。
- 如果「体动提示」标记闪烁，请将手臂恢复到正确的姿势（参照第6,7页）
- 身体活动时的血压判定显示「体动提示」标记闪烁。有体动时的测量值显示时，「体动提示」标记也闪烁。

（存储的有体动时的测量值，在调出时「体动提示」标记也显示）

「体动提示」 标记显示	说 明
 闪烁	感知身体活动 <ul style="list-style-type: none"> ●无意中弯曲手或手腕 ●手或手腕用力较大 ●手或手腕活动时 等 请恢复到正确的姿势再次测量 （参照第6,7页）
 显示	导致测量值产生较大差异的动作 <ul style="list-style-type: none"> ●大幅度动作 ●多次动作 ●手或手腕较大动作 等 显示部显示标记“E”时，请再测量。 ※如下状态时（画面显示“E”） <ul style="list-style-type: none"> ●袖带尼龙搭扣松开

※此功能是为正确测量而设置的参考性功能。

为了正确的测量血压，建议即使“体动提示”标记()未闪烁时，也请您在安静状态下测量2~3次。（参照第6,7页）

使用方法

测量方法

关于「心率不齐」提示的功能

是指在测量过程中，当检测到心率与平均值之间差大于±25%的脉搏时，测量结束后会出现“心率不齐”标记，来提醒使用者。

- 测量结束后，“心率不齐”标记在闪烁约6秒钟后显示。
- “心率不齐”标记显示时，请重新测量。
- 测量过程中如果心率变化大的话，可能影响测量值的准确性。

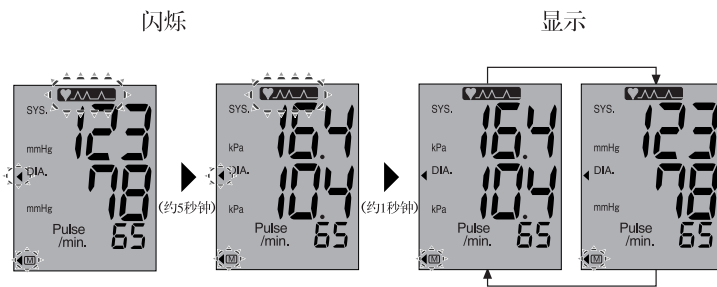

*测量结果以mmHg(血压值)、kPa(血压值)交替显示。

- 存储并调出有心率变动时的测量值时，则“心率不齐”标记显示。

该标记并非为告知心率失常的信号。

※本功能是为了保证测量值的准确性而设定的参考性功能。

即使未显示“心率不齐”标记，为了保证测量的准确性，建议您在安静的状态下测量2~3次。（参照第7页）

※如果标记频繁出现，则应就自己的健康状况向医生咨询。

请勿自己判断测量结果，进行治疗。请务必遵从医嘱。

使用方法

测量方法

「血压指示」的读法

对于最高·最低血压值以WHO/ISH(世界卫生组织/国际高血压学会)的血压分类表为标准判断是属高血压区域还是属正常区域,由三种颜色的指示灯向使用者提示。

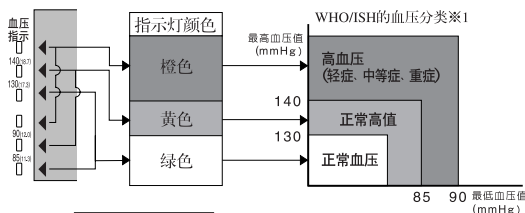

●测量值在高血压区域时, mmHg和kPa交替显示。(约6秒钟)

最高血压 18.7kPa(140mmHg)以上
 最低血压 12.0kPa(90mmHg)以上
 (仅在测量结束时) (1kPa=7.5mmHg)

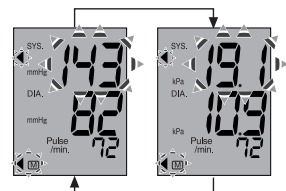

不能正确测量时

E

显示重新测量符号“E”

继续测量时,按下开始▶结束钮暂时关闭电源,请务必静候4~5分钟后再进行测量。

建议

与第一次相比,第二次测量时的状态更加平稳,血压也会有所回落。特别对于易紧张类型的人,两次记录更为有效。二次测量时,通常记录数值较小的测量值。第二次测量时,请在第一次测量后务必安静4~5分钟。

※1 1999 World Health Organization-International Society of Hypertension Guidelines for the Management of Hypertension

使用方法

测量值的记忆和调出

测量值的记忆 本产品可存储测量数据90组。

- 在电池电量不足时、更换电池时、取出电池的情况下,记忆内容仍可以被保存。

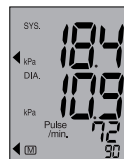

1 测量结束后, (M) 标记显示, 按记忆/调出钮。

2 记忆结束

- 可记忆90个测量值。此后再存入新数据时,最先输入的数据将被取代。测量值的序号号变更。
- 不能正确测量时(血压值显示「E」),测量值无法存储。测量值的序号号也不变更。
- ※但是,脉搏值显示「E」时,测量值仍可被存储。

使用方法

测量值的记忆和调出

测量值的调出

存储测量值后或关闭电源的状态下，均可以调出所存储的测量值。

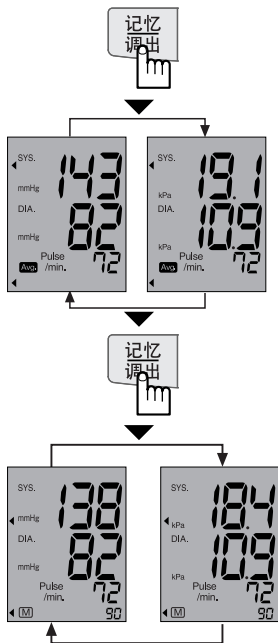

1 按记忆/调出钮

- 显示所记忆的全部测量值的平均值
- 「Avg.」标记显示
- 例：如果所记忆的数据为90个，则显示90个数据的平均值。
(仅记录1个数据时,「Avg.」标记不显示。)

2 如果再按一次记忆/调出钮，则显示最新的测量值。

- 每按一次记忆/调出钮，则从最新的测量值开始依次显示。

3 关闭电源时，按开始▶结束钮即使忘记关闭电源，约30秒钟电源也会自动关闭。

若想删除所记忆的全部测量值时

- ①按记忆/调出钮调出所记忆的测量值。
 - ②持续按住记忆/调出钮约3秒钟以上，直至测量值消失。
- ※测量值不能逐个地删除。
- ③所有数据一旦被删除则显示「M」标记和「00」标记。

其它

使用结束后

收藏血压计时

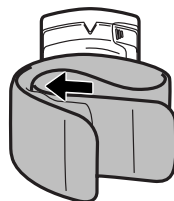

1 按箭头所示方向，折叠袖带

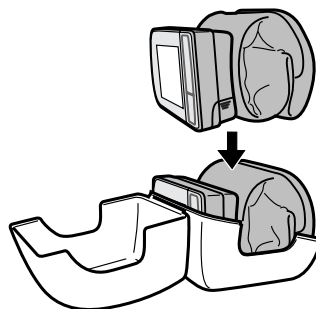

2 放入收藏盒中

- 防止袖带被收藏盒所夹。

其它

测量时的注意点

如下场合时无法测得准确的血压

饭后1小时以内
或饮酒以后

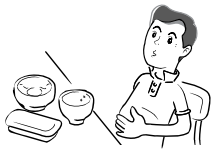

喝咖啡、红茶、
吸烟后



在运动的交通工具
中



运动或洗浴后



请安静20分钟以后再
进行测量。

在寒冷的场所测量



请在20℃左右的室温中
进行测量。

有尿意时



排尿后, 请等待几分钟
后再进行测量。

手腕与上臂的血压差



对于有糖尿病、肝病、肾病、动脉血管硬化、高血压症等手足的血液循环状况不佳者*2，末梢循环障碍者，手腕部血压值与上臂部血压值可能有较大差异。

所以，不可自行判断，必须接受医生的指导。

*2 由于存在基础疾患，因此手脚部分血液循环不畅的人。

其它

Q&A

Q 在医院测量的血压值和在家里测量的血压值为何不同？

A. 血压在24小时之内都在变动，另外由于气候、情绪、运动等原因有时会有较大的变动。特别是在医院里有所谓的「白衣性高血压」现象，由于紧张或不安有时比在家里测量的血压值高。

在家里所测量的血压值比在医院高时，请注意以下几点：



①主机的高度是否与心脏在同一水平线。
主机的位置比心脏低时，所测量的血压值偏高。



②袖带卷绑太松弛。
将袖带绑紧在手腕上。



③是否感到不安或焦躁。
测量前请深呼吸2~3次，放松下来使血压稳定。

Q 为什么每次测量的血压值都不一样？

A.

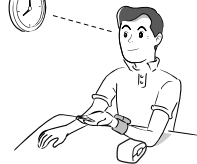

- ① 血压即使在一天之内也在不断地变化，同时也会因袖带的卷绑方法、测量姿势不同而不同。所以每次测量时，请在相同的条件下测量。
- ② 服用降压药的人，因药效的作用，血压值有时变化很大。
- ③ 连续2次测量时，中间必须安静4~5分钟以上。

Q 用左右手测量时，测量值是否相同？

A.

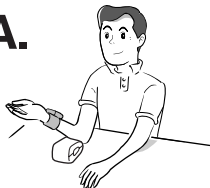

左右手任何一侧都可以测量。但是，左右手的血压差值可能约10mmHg，因此，每次都请用相同侧手腕测量。

Q 手或手腕虽动，但是「体动提示」标记不显示？

A. 所谓「体动提示」，是指在测量过程中，手或手腕等活动向袖带提供了多余的压力时，通过此标记进行提示的功能。

因此当出现对袖带没有影响的动作（如：轻轻转肘部等），「体动提示」标记可能不显示。

如果您对测量值有疑问时，请重新测量。

Q 经「体动提示」的提示，修正了手或手腕位置，但测量值偏高？

A. 「体动提示」仅仅是对测量姿势是否正确的一种参考提示。（参照第9页）

经「体动提示」提示，恢复了正确测量姿势，但测量值还是偏高或偏低时，请再次测量。

出现上述情况时，可考虑以下因素：

- 测量是否正确（袖带的卷法、姿势等）（请参照第5~7页）
- 吸烟后马上测量
- 情绪不稳定时
- 寒冷的环境
- 脉搏变化小的人
- 如果您对测量值有疑问，请安静4~5分钟后再次测量。

Q 何时测量较好？

A. 一天中测量3次比较好

第一次… 起床时(最接近夜间的血压，且基本无因身体的活动而产生的影响。)

第二次… 中饭前(无饮食的影响，且最接近一天中的最高血压值)

第三次… 就寝前(测量值最接近一天中的血压平均值)

通过早、中、晚的测量，掌握自己的血压状态，轻松管理自己的血压。

防止故障

请勿修理、拆卸和改造。

请勿将主机摔掉在地上，避免受到碰撞或强烈冲击。

- 否则会造成故障

请不要将血压计从0℃以下的场所取出后马上使用

至少要在温暖环境下保暖1小时以上

- 否则就会造成不能正常加压

除了使用沾有温水或肥皂水的布以外，勿用其它东西进行擦拭。

（切勿使用酒精、汽油及稀释剂）

- 否则可能导致变色或出现裂纹

袖带不能冲洗

切勿逆方向弯曲袖带。袖带仅用于测量血压时卷绑手腕。

- 否则可能使袖带裂

防止灰尘或异物进入血压计内。

- 否则会造成故障。

测量过程中请勿碰触主机

- 否则不能正确测量

长时间不使用时(1个月以上)要取出电池。

- 否则会产生漏液而引发故障。

避免把血压计存放在高温、潮湿及阳光直接照射的场所。

- 否则会造成故障。

其它

发生异常时

显示	异常现象	原因及处置	仍存在异常时
「再测量」的“E”显示 	▶ 加压至280mmHg以上	▶ 测量方法或姿势是否正确？ (参照第6~7页)	
	▶ 压力急速下降，显示出“E”。	▶ 袖带卷绑是否正确？ (参照第5页)	
	▶ 心脏标记(♥)仅闪烁数次(或完全不闪烁)		
	▶ 不加压		
	▶ 手和手腕大幅度活动。	▶ 是否检测到体动 (参照第9页)	

症状	可能的原因	仍存在异常时	请接受医生的指导
最高血压值或最低血压值偏高或偏低	<ul style="list-style-type: none"> • 测量时，主机的位置相对于心脏的高度偏高或偏低 • 袖带没有正确卷绑 • 测量时出现动作或讲话 (参照第5~7页) 		
与医生测量的血压值不一致	<ul style="list-style-type: none"> • 在医生面前的心理状态的微妙变化。 • 至少放松4~5分钟以后再重新进行测量。 (参照第6~7页) 		
每次测量的血压值都不一致			

其它

发生异常时

症状	可能的原因	仍存在异常时
即使按开始▶结束钮也无显示	▶ 电池⊕/⊖极安装错 (参照第4页)	
按开始▶结束钮，但在加压过程中，显示消失。(C)标记显示)	▶ 电池消耗完毕 (参照第4页)	
测量过程中，「♥」标记闪烁。	▶ 测量过程中，心率发生大的变化。 (参照第10页)	
测量过程中，「手」标记闪烁。	▶ 手或手腕移动 (参照第9页)	
手或手腕未动，但「手」标记闪烁。	▶ 有时手上用力时也会有反应，请在放松状态下测量。 (参照第9页)	
加压过程中声音和加压速度变化	▶ 因为是在加压过程中测量，因此在加压过程中动作声音与加压速度出现变化，这并不是故障。	
主机破损	敬请协作 请勿自行修理，并请务必委托本公司指定的电子血压计技术服务代理店进行检查、修理。	

规格

电 源	DC3V 7号碱性电池2节
显示方式	数字式液晶显示
测量方式	示波法检测方式
测量范围	压 力: 0kPa~37.3kPa(0mmHg~280mmHg) 脉搏数: (30~160)次/分
准 确 度	压 力: 15℃~25℃ ±0.4kPa(3mmHg)以内 5℃~40℃(15℃~25℃以外) ±0.8kPa(6mmHg)以内 脉搏数: ±5%以内
加 压 速 度	0.5kPa/s~1.1kPa/s(3.75mmHg/s~8.25mmHg/s)
正常工作环境	温 度 5℃~40℃ 相对湿度 ≤80%
贮存运输环境	温 度 -20℃~55℃ 相对湿度 10%~93%
可测量的手腕周长	约12.5cm~22.0cm
重 量	约111克 (不含电池)
外形尺寸(主机)	长78mm×宽54mm×厚26mm
安 全 分 类	内部电源B型
加 压 方 式	振动片式泵的加压调整方式
快速排气方式	急速排气阀开放方式
压 力 检 测	半导体压力传感器
脉 搏 检 测	半导体压力传感器
企业标准号	Q/DXBSX005-2007
注册标准号	YZB/京0059-2007
医疗器械生产企业许可证号	京药监械生产许20000034号

*如果在规定的温度和湿度范围外储存和使用,可能无法达到规定的性能规格。

合格证:



EW3038 Wrist Blood Pressure Monitor

- This instrument is an automatic electronic sphygmomanometer for measuring wrist blood pressure. The values of blood pressure and pulse can be easily measured by using oscillography.
- Applicable to the measurement of human body's blood pressure and pulse without traumatism.
- The wrist circumference that can be measured with this Wrist Blood Pressure Monitor is about 12.5cm-22.0 cm.

Our promise

Any malfunction occurring within of purchase will be dealt with according to the rules in Repair Card attached to the product.

Packing list

- ① Main unit (with pressure cuff) 1
 - ② Storage case 1
 - ③ AAA-size batteries 2
 - ④ User manual 1
 - ⑤ Repair card 1
 - ⑥ Certificate 1
 - ⑦ Record card for blood pressure measurement 1
- Included batteries are for device testing. Please verify the functions of the device during purchase.

Content

Important Safety Instructions	23
Parts Identification	24
Preparation	25
• Preparations Before Measurement	25
• Positioning The Cuff	26
How to Use	27
• Instructions for correct measurement	27~28
• Methods of measurement ...	29~32
• Save and read measured values	33~34
Other	35
• After Use	35
• Cautions During Measurements	36
• Q&A	37~39
• Care And Maintenance	40
• Troubleshooting	41~42
• Specifications	43

IMPORTANT SAFETY INSTRUCTIONS

- * Before using this instrument, please read the "IMPORTANT SAFETY INSTRUCTIONS" and be sure to use the instrument properly.
- * The cautions in this section are intended to instruct you in the proper use of this instrument and prevent danger or injury to yourself or other people.

All of the cautions contain important information regarding safety and must be followed.

WARNING: Failure to follow the caution may result in death or serious injury of people.

CAUTION: Failure to follow the caution may result in injury to people, or in damage to property.

WARNING:

Persons with serious obstructions of blood flow in the arm should consult a doctor before using this instrument. Failure to do so may result in deterioration of physical condition.

CAUTION:

- Do not make judgements yourself regarding the measurement results or self-treat yourself.
- There will be large differences between wrist blood pressure values and upper-arm blood pressure values for persons with periphery circulatory obstruction due to diabetes, liver disease, kidney disease, arteriosclerosis, high blood pressure, etc.
- Take measurements according to your doctor's instructions and have your doctor do the diagnosis.
- Take medicine according to your doctor's instructions.
- Do not use for purposes other than the measurement of blood pressure. Doing so may result in an accident or malfunction.
- Do not use this instrument on infants or on people who cannot express their feelings. Doing so may result in problems or an accident.
- Do not disassemble this instrument, or attempt to repair or modify it yourself. Doing so may result in an accident or malfunction.

SAVE THESE INSTRUCTIONS

PARTS IDENTIFICATION

Please check the instrument.

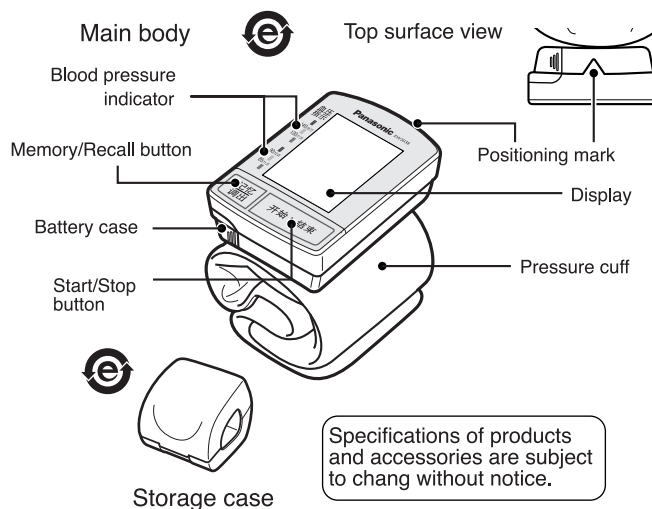

<About batteries>

- Panasonic alkaline batteries (two AAA-size batteries) can provide approximately 300 uses (for measurements 3 times a day, approximately 3 months of use). (Measurement conditions: Room temperature: 23*; Pressurized to 170 mmHg (22.7kPa); Wrist circumference: 17cm)
- Batteries are included only for testing purposes and with no guarantee of battery life. (In some areas batteries are not included with the unit.)
 - At lower room temperatures, battery life will be reduced.
 - When using batteries other than alkaline batteries, the number of uses may be greatly reduced. Always use alkaline batteries.
 - When installing batteries, both batteries should be of the same type and from the same manufacturer, and should be installed together at the same time.
 - If the instrument will not be used for a long period of time, remove the batteries. Leaving the batteries installed may result in battery leakage and damage to instrument.
 - Do not discard batteries with normal garbage. Take to recovery center.

PREPARATIONS BEFORE MEASUREMENT

* Always use alkaline batteries.

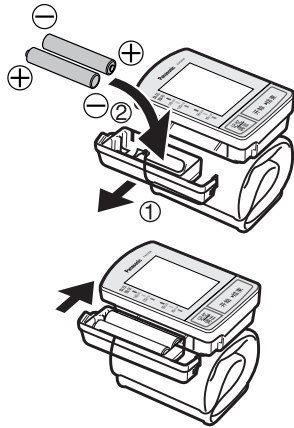

- 1** Remove the unit from its storage case.
Inserting dry cell batteries.
(1) Remove the battery case by pushing it in the direction of the arrow.
(2) Insert the batteries, ensuring the correct polarity.
- 2** Slide the battery case back into place on the main body until it clicks into place.

⚠ CAUTION:

- Always follow the cautions printed on the batteries.
- Check the polarities of the batteries and install them correctly.
- Promptly remove exhausted batteries.
- If the product will not be used for a long time, remove the batteries.
- Batteries should be used before their expiration date.
Use after the expiration date may result in injury or staining of the surrounding area due to generation of heat, bursting, or leakage.

Replace batteries when:

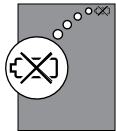

- The mark shown at right appears during measurement.
- No display is shown when the Start/Stop button is pressed.

POSITIONING THE CUFF

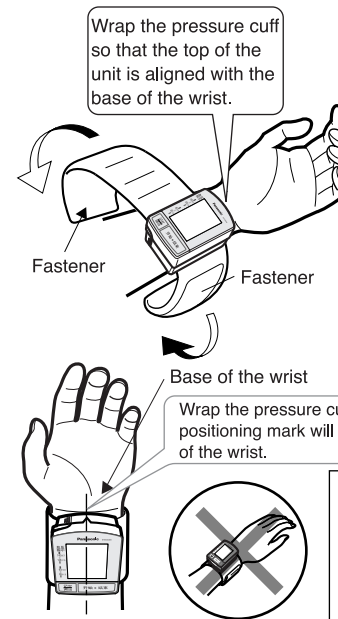

- 1 Attach** on the inside of the wrist.
 - Wrap the cuff on bare skin.
 - Measurable wrist circumference: 12.5cm to 22.0cm
- 2 Fasten** the cuff firmly
 - If the cuff is wrapped loosely, the measured value for blood pressure will be high.
 - Avoid twisting the belt when fastening.

- Do not remove the hook and loop fastener by twisting it off.
Be sure to peel it in an upward direction in alignment with the cuff.

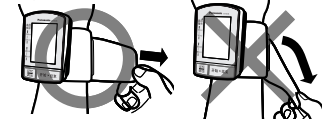

When measuring on the right wrist:

Position the blood pressure monitor as shown in the figure.



The blood pressure monitor can be used by wrapping the cuff on either wrist. However, since it has been said that the difference in blood pressure between the left and right wrists may be around 10mmHg, be sure to always use the same wrist for measurements.

FOR ACCURATE MEASUREMENTS

Take measurements at around the same time every day, using the same wrist and in the same posture.

- When taking measurements in the morning, take the measurement immediately after waking up when there is no urge to urinate, or if that is difficult, take measurements before eating breakfast without moving your body.

Before measurements, be sure to sit quietly for 4 to 5 minutes.

When measuring while sitting down:

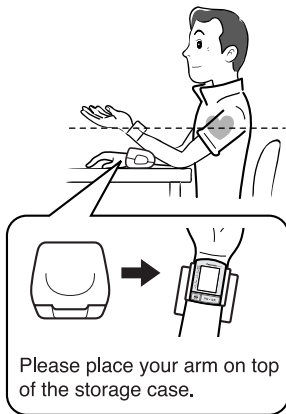

- 1 Rest your elbows** on a table.
- 2 Position yourself so that the blood pressure monitor is at the same level as your heart.**
- 3 With the palm of the hand facing up, release any tenseness in your muscles.**

If measurements are taken with the wrist or hand in the following positions, accurate measurements will not be obtained.

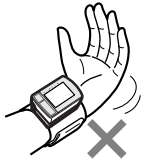

Wrist is bent inwards.



Wrist is tense and fist is being made.

If the blood pressure monitor is positioned lower than the heart, the measured blood pressure value may be high.



If the posture applies pressure to the stomach (leaning forward), accurate measurements may not be possible.



Do not move your body, your arm, or your fingers while taking measurements.



Do not use the blood pressure monitor near cellular phones or other devices which emit electromagnetic waves. Doing so may result in malfunction.

If the blood pressure monitor is positioned higher than the heart, the measured blood pressure value may be low.



Do not touch the blood pressure monitor while taking measurements.



Do not talk while taking measurements.



TAKING A READING

Stay quiet and relax while taking measurements.

1 Place the storage case under your arm. (Refer to "FOR ACCURATE MEASUREMENTS" on pp.27 and 28.)

2 Press the 开始 / 结束 button.

- All displays will be shown for approximately 2 seconds.
- Pressurization will start automatically.
- The heart ♥ mark will blink when pulse is detected during pressurization.

Since measurements are performed during pressurization, there may be changes in operating sounds or the pressurization rate during pressurization. This is normal and is not a malfunction.

3 When measurement has been completed, the blood pressure value and pulse rate will be displayed.

- Pressure will be automatically released from the pressure cuff.
- The blood pressure values and pulse number are displayed at the same time. Blood pressure values are displayed alternately in mmHg and kPa units.
- If the measured value is in the high blood pressure region, the values will blink (for approximately 6 seconds). (For how to read the blood pressure display, see p.32)
- The **(M)** mark will blink. (For measurement values which can be stored, see p.33~34)
- The pulse rate value is the beats per minute calculated based on the pulse rate during measurement.

To switch off the blood pressure monitor, **press** the 开始 / 结束 button.

- If you forget to switch off the blood pressure monitor, it will switch off automatically after approximately 5 minutes.

MOVEMENT DETECTION FUNCTION

If the wrist bound with sleeve strap flexes unconsciously during the measurement, the blood pressure results may be inaccurate at times.

- The "Movement Detection Function" is a function that detects excess pressure on the wrist strap caused by movement of the user's hand or wrist during blood pressure measurement and shows the "Movement Detection" symbol in the display when this occurs.
 - If the "Movement Detection" symbol blinks, please resume the proper position of your arm (see pp.27 and 28).
 - The "Movement Detection" symbol will blink if the body moves during blood pressure measurement. When the result is displayed and the body was moving during measurement, the "Movement Detection" symbol will also blink.
- (When a saved result, measured while the body was moving, is selected, the "Movement Detection" symbol will also blink.)

"Movement Detection" symbol display	Explanation
	<p>Body movement detected</p> <ul style="list-style-type: none"> • Involuntary flexure of the hand or the wrist. • Overexertion of the hand or wrist. • Movement of the hand or wrist etc. <p>Please resume the right position and measure again (refer to P27-28).</p>
	<p>Movement that may cause inaccurate measurement result occurred:</p> <ul style="list-style-type: none"> • Large degree of movement • Multiple movements • Large degree of movement of the hand or wrist etc. <p>When "E" is displayed on the screen, please measure again. ("E" will be displayed when:)</p> <ul style="list-style-type: none"> • The fastener of sleeve strap is loose.

*This is a reference function that designed for accurate measurement. In order to obtain more accurate blood pressure measurement results, please measure for 2-3 times under static status even if the "Movement Detection" symbol does not blink (see p.27).

TAKING A READING (CONTINUED)

IRREGULAR PULSE DETECTION FUNCTION

If the heart rate measured exceeds the average value for more than $\pm 25\%$ during measurement, the symbol of "Irregular Pulse" will be displayed to remind that attention is needed after measurement.

- After measurement, the symbol of "Irregular Pulse" will be displayed after 6 seconds of blinking.
- When the symbol of "Irregular Pulse" is displayed, please measure again.
- If the heart rate changes too much during measurement, it may affect the accuracy of measured value.

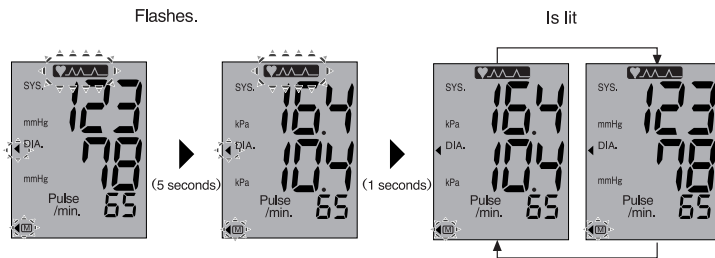

* Blood pressure values are displayed alternately in mmHg and kPa units.

- When you save and select the value measured with irregular pulse, the symbol of "Irregular Pulse" will be displayed as well.

This symbol is not designed to indicate irregular pulse.

- This is a reference function intended for ensuring the accuracy of measured value. In order to ensure the accuracy of measurement, please measure for 2-3 times under static status even if the symbol of "Irregular Pulse" is not displayed. (see.p.28)
- If the symbol appears constantly, you should consult a doctor regarding your health condition.

Please do not estimate the result and receive treatment by yourself: doctor's advice must be followed.

Reading the blood pressure display

Whether the systolic and diastolic blood pressure values are in the high blood pressure region or normal blood pressure region are judged based on the WHO/ISH (World Health Organization/International Society of Hypertension) blood pressure classifications, and the blood pressure value blinks if required.

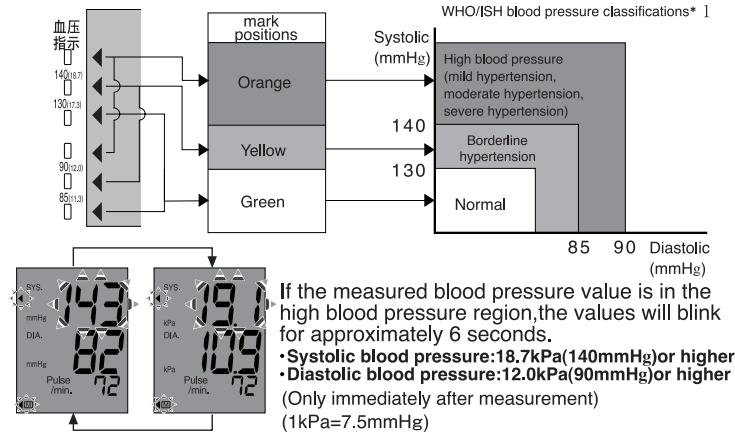

If measurements could not be taken properly



The remeasure mark "E" will be displayed.

When taking successive measurements, press the 开始/结束 button to switch off the blood pressure monitor once and stay quiet for 4 to 5 minutes, and then take the next measurement.

Advice:

Often with the second measurement, there is less tension and you feel more relaxed, so the blood pressure value is lower. For people who easily get tense, measuring twice each time is very effective. When two measurements are taken, normally the smaller measurement is stored. When taking two measurements, always stay quiet for 4 to 5 minutes after the first measurement before taking the second measurement.

※1 1999 World Health Organization-International Society of Hypertension Guidelines for the Management of Hypertension

STORING AND RECALLING MEASUREMENT VALUES

This product can store up 90 sets of readings.

Storing measurement values

- Stored data will remain in memory even if batteries become exhausted or batteries are removed.

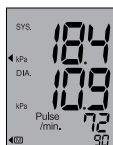

- 1 After measurement, **press** the 记忆 /调出 button while the **(M)** mark is blinking.

2 Storing is completed.

- Up to 90 measurement values can be stored. When the memory is full and additional values are stored, the oldest value in memory will be deleted and the new value will be stored. At that time, the data numbers for the measurement values will change.
- If measurements could not be taken properly (the **E** mark is shown instead of the blood pressure value), measurement values cannot be stored. Data numbers will not be changed.
- However, if only the pulse rate value shows the **E** mark, measured blood pressure values can be stored.

Recalling measurements

Measurements can be recalled after measurement is completed or after the power has been switched off.

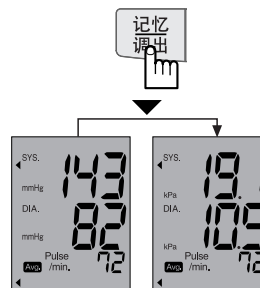

- 1 **Press** the 记忆 /调出 button.
 - The average of all measured values in memory will be shown.
 - The **(Avg.)** mark will be lit.
 - For example, if 90 measured values are stored, the average of 90 measurements will be shown. (If only 1 measurement is stored, the **(Avg.)** mark will not be shown.)

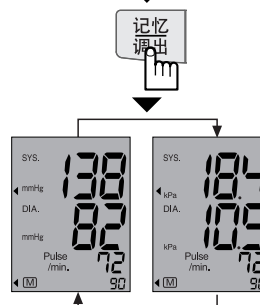

- 2 If you press the 记忆 /调出 button again, the most recent stored measurement value will be shown.
 - Each time the 记忆 /调出 button is pressed, the stored measurement values will be recalled in order, starting with the most recent.
 - If no measurement value is stored, the value will not be displayed.

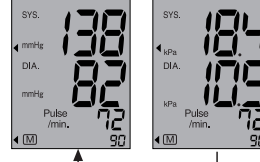

- 3 To switch off the blood pressure monitor, **press** the 开始 /结束 button. If you forget to switch off the blood pressure monitor, it will switch off automatically after approximately 30 seconds.

To erase all measured values stored in memory:

- ① Press the Memory/Recall button to recall stored measurement values.
- ② Press the Memory/Recall button again and hold it pressed until the measurement values disappear (longer than approximately 3 seconds).
 - * It is not possible to erase single measurement values.
- ② When all measurement values have been deleted, the **(M)** mark and **99** will be displayed.

AFTER USE

Storage

1

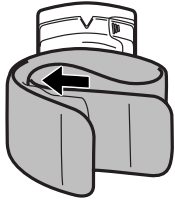

1 Fold the pressure cuff as indicated.

2

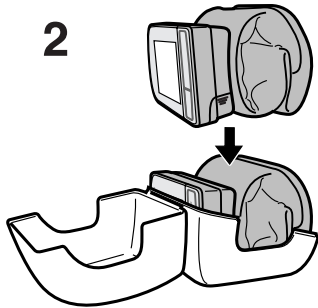

2 Put the blood pressure monitor in the storage case.

Avoid pinching the cuff with the storage case.

CAUTIONS DURING MEASUREMENTS

In the following situations, accurate measurements cannot be taken.

Within 1 hour of eating or drinking alcohol

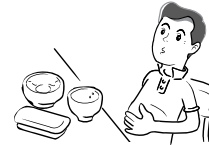

Immediately after exercising or taking a bath



Wait at least 20 minutes and take a measurement while staying quiet.

Immediately after drinking coffee or tea, or smoking



In cold places



Measurements should be taken at room temperatures of around 20°C.

In a moving vehicle



When you need to urinate



Wait several minutes after urinating before taking measurements.

Difference between wrist and upper-arm blood pressure values



There may be large differences between wrist blood pressure values and upper-arm blood pressure values for persons with periphery circulatory obstruction due to diabetes, liver disease, kidney disease, arteriosclerosis, high blood pressure, etc.*1

Because of this, do not make judgements regarding blood pressure yourself. Always follow your doctor's directions.

*1 Persons with basic diseases and poor circulation in the wrist.

Q & A

Q Why are the blood pressure values measured at home different from those measured at the doctor's office?

A Blood pressure varies 24 hours a day.

In addition, it can change greatly depending on the weather, your mental state, exercise, etc.

In particular, there is the phenomenon of "White uniform hypertension" at doctor's offices, where the blood pressure measured in a doctor's office is higher because of stress or worry.

In addition, if the blood pressure measured at home is higher than that measured at the doctor's office, the following points should be considered and care should be observed where necessary:



- ① The blood pressure monitor is not at the same height as the heart.
If measurements are taken with the blood pressure monitor lower than the heart, the measured blood pressure values will be higher.



- ② The pressure cuff is wrapped loosely.
Wrap the pressure cuff securely around the wrist.



- ③ Do you feel worried or irritated?
Before taking measurements, take 2 or 3 deep breaths and relax to stabilize blood pressure. In addition, it is recommended that you sit quietly for about 4 to 5 minutes before taking measurements.

Q & A

Q Why are measured blood pressure values different each time I take a measurement?

A

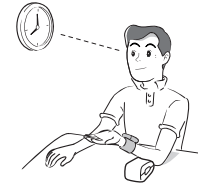

- ① Blood pressure varies throughout the day, and can also vary depending on how the pressure cuff was wrapped or your posture. Because of this, measurements should be taken at the same time and under the same conditions every day.
- ② For persons taking blood pressure medication, blood pressure may change greatly due to the effects of the medication.
- ③ When taking 2 measurements in succession, be sure to stay quiet for 4 to 5 minutes after the first measurement before taking the next measurement.

Q Why are the measured values different for the left and right wrist?

A

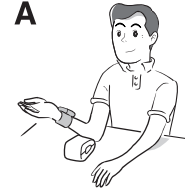

It is said that differences in blood pressure values between the left and right wrists may be around 10 mmHg. The blood pressure monitor can take measurements on either the left or right wrist, but all measurements should be taken using the same wrist.

Q The "Movement Detection" symbol is not displayed while the hand or the wrist is moving. why?

A

The "Movement Detection Function" is a function that detects excess pressure on the sleeve strap which is caused by movement of the user's wrist during measurement and displays the "Movement Detection" symbol when this occurs. Because of this, the "Movement Detection" symbol may not be displayed if the movement does not affect the sleeve strap.

If you are unsure about the measurement, please do it again.

Q & A

Q The measured value is unusually higher although the position of the hand and the wrist is fixed according "Movement Detection" symbol. Why?

A The "Movement Detection" symbol is just a reference indication for correct measurement posture(see pp.30).
If the measured value is unusually higher or lower after the symbol of "Movement Detection" is displayed, please measure again.
If the above situations occurs, the following factors may exist:

- Incorrect measurement method (the binding method of sleeve strap, posture, etc)?
Please refer to the methods of pp.27 ~ 28.
- Measurement immediately after smoking.
- Measurement when user's mood is not steady.
- Measurement in cold circumstance.
- The change of user's pulse is small.

If you are unsure about the measured value, please measure again after 4-5 minutes rest.

Q When should I measure my blood pressure?

A We recommend that you measure your blood pressure 3 times a day.

First time: When you get up in the morning. (This is when your blood pressure is most typical of its value during the night and when the movements of your body have had hardly any effect on it.)

Second time: Before eating lunch. (This is when your blood pressure is not affected by food and when it is most typical of the highest level of the day.)

Third time: When you go to bed at night. (This data value is roughly typical of the average blood pressure value for the day.)

Get to know your blood pressure pattern by measuring your blood pressure in the morning, at midday and in the late evening, and use the data you obtain to manage your blood pressure.

CARE AND MAINTENANCE

Do not disassemble the instrument or attempt to repair or modify it.

Always wrap the pressurization cuff around the wrist for use. Do not bend the pressurization cuff backwards.

- Doing so may damage the pressurization cuff.

Do not apply excessive force to the instrument or drop the instrument.

- Doing so may cause damage.

Do not insert dust or foreign objects into the instrument.

- Doing so may result in damage.

If the instrument is stored at temperatures below the freezing point, do not use it immediately. Leave it in a warm place for at least an hour before use.

- If the instrument is not allowed to warm up, it may not pressurize.

Do not touch the instrument during use.

- Doing so may prevent accurate measurements.

If the instrument becomes dirty, clean it with a soft cloth moistened with warm water or soapy water. (Do not use alcohol, benzine, or paint thinner.)

- Use of such chemicals may result in cracking or discoloration.

If the instrument will not be used for a long period of time (more than 1 month), remove the batteries.





- Leaving the batteries installed may result in battery leakage and damage to the instrument.

The pressure cuff cannot be washed.





For storage, avoid high temperatures, high humidity, and direct sunlight.

- Storage under such conditions may result in damage.

TROUBLESHOOTING

Display	Status before error	Cause and solution
Remeasure  mark is displayed. 	Pressurization to more than 280 mmHg was performed.	Were measurements taken according to the proper procedure and in the correct posture? See pp. 27~ 28.
	Pressure decreased suddenly and the remeasure mark  appeared.	
	The heart mark  blinked only a few times or not at all.	Was the pressurization cuff wrapped properly? See p. 26.
	No pressurization	
	Your hand or wrist moved.	Has the unit detected movement? See p. 30.

Symptom	Possible cause
Systolic or diastolic blood pressure value is high or low.	<ul style="list-style-type: none"> • During measurement, the level of the instrument was higher or lower than the level of the heart. • The pressure cuff was not wrapped properly. • You moved or talked during measurement. See pp. 26 to 28.
Value is different from that measured by the doctor.	<ul style="list-style-type: none"> • Blood pressure varies in response to minute changes in your mental state, such as your reaction to the doctor's presence. • Relax 4 or 5 minutes, and take another measurement. See pp. 27~ 28.
Measurement values are different with each measurement.	

Symptom	Possible cause
No display appears even when the Start/Stop button is pressed.	<ul style="list-style-type: none"> • Batteries are installed backwards. See p.25. • Batteries are exhausted. See p. 25.
When the Start/Stop button is pressed, the display disappears during pressurization ( mark appears).	
During pressurization, the sound or pressurization rate changes.	<ul style="list-style-type: none"> • Since measurements are performed during pressurization, there may be changes in operating sounds or the pressurization rate during pressurization. This is normal and is not a malfunction.
The  mark flashes when readings are being taken.	<ul style="list-style-type: none"> • There was a significant fluctuation in pulse when readings were being taken. See p. 31.
The  mark flashes when readings are being taken.	<ul style="list-style-type: none"> • Your hand or wrist moved. See p. 30.
The  mark flashes even though I did not move my hand or wrist.	<ul style="list-style-type: none"> • In some cases this will be displayed when you have tensed the muscles in your arm. Relax the muscles in your arm and take the reading again. See pp. 27~ 28.
Damage of the main unit	<ul style="list-style-type: none"> • Do not repair it yourself. Please contact our designated service agency for wrist blood pressure monitors to examine and repair the device.

***The warranty of this product is only valid in the PRC (Not available in Hongkong, Macao and Taiwan for the time being)**

Specification

Power	DC3V AAA-size alkaline batteries × 2
Display mode	Digital LCD
Measurement mode	Oscillometric system
Measurement range	Pressure: 0kPa~37.3kPa(0mmHg~280mmHg) Pulse rate: (30~160)beats/minute
Accuracy	Pressure:15℃~25℃within ±0.4kPa(3mmHg) 5℃~40℃(out of 15℃~25℃)within ±0.8kPa(6mmHg) Pulse rate: within ±5%
Rate of pressurization	0.5kPa/s~1.1kPa/s(3.75mmHg/s~8.25mmHg/s)
Operating condition	Temperature 5℃~40℃ Relative humidity ≤ 80%
Storage & transportation condition	Temperature -20℃~55℃ Relative humidity 10% ~ 93%
Measurable wrist circumference	About 12.5cm~22.0cm
Weight	Approx. 111g (Excluding the batteries)
Dimensions (Main part)	Approx.78mm × 54mm × 26mm
Protection against electric shock	Internally powered equipment, Type B applied part
Pressurization mode	Pressure-regulated mode of oscillating-mode pump
Fast air-discharging mode	Fast-open air-discharging valve mode
Pressure detection	Semiconductor pressure sensor
Pulse detection	Semiconductor pressure sensor

Certificate

