

京制00000345号
京药监械(准)字2007第2210453号
YZB/京0059-2007
京药监械生产许20000034号

Panasonic®

电子血压计
Wrist Blood Pressure Monitor

使用说明书
Operating Instructions

型号:EW3039
Model No.EW3039

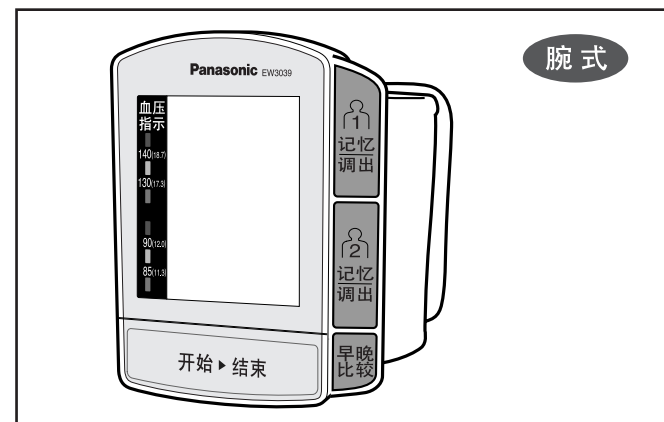

- 感谢您购买本公司产品。
- Thank you for buying our product(s).
- 使用之前请您务必仔细阅读本使用说明书。
- Please read the manual carefully before you use the product for the first time.
- 请您务必妥善保管本使用说明书。
- Please keep the manual in a safe and proper place.



北京松下电工有限公司
Panasonic Electric Works(Beijing)Co.Ltd
地址: 北京经济技术开发区同济北路1号
Add: 1#Tong Ji North Road,Beijing Economic
& Technological Development Zone,Beijing,CHINA
原产地: 中国 (Made in China)
邮编: 100176 电话: (010)-67882437
Post: 100176 Tel: (010)-67882437

W9030 3039101
B1107-0
Printed in China

安全注意事项

※使用之前，请仔细阅读本“安全注意事项”，以便正确使用。

※为避免使用者因使用不当而遭受危害或损失，请参阅“安全注意事项”，正确使用本产品。

为安全起见，请务必遵守本安全注意事项。

 表示注意、警告内容。





 警告：可能导致人的死亡或重伤的内容。

 注意：可能导致人受到伤害以及物质上的损失的内容。

 表示禁止行为。

 表示禁止分解。

 表示B型设备。

 警告	
 务必遵守	<ul style="list-style-type: none"> ●腕部有重度血液循环障碍者，使用前请向医生咨询。否则有可能引起身体不适。
 注意	
 禁止	<ul style="list-style-type: none"> ●自己判断测量结果而进行治疗十分危险。 <ul style="list-style-type: none"> ●请将测量结果交给了解您健康状况的医生并接受诊断。 ●如果服用药剂请遵医嘱。 ●对于那些因某些疾病引起的末梢循环障碍者，在手腕和上臂部测量的血压值可能会出现较大差异。 ●请勿用于血压测量以外的用途。否则将有可能引起事故或发生故障。 ●请勿让婴幼儿和无法表达自我意识的人使用。否则将有可能引起事故。
 禁止分解	<ul style="list-style-type: none"> ●请勿私自进行拆卸、修理和改造。否则将有可能发生事故和故障。

※请将本说明书妥善保管。

EW3039型血压计

- 本型号血压计为用于手腕测量的全自动电子血压计，应用示波法，能够快速、简便地测量血压值和脉搏数。
- 本型号血压计适用于人体无创式血压和脉搏的测量。
- 本型号血压计可测量的手腕周长约为12.5cm~22.0cm。

本公司承诺：

保修期内的血压计如发生故障，按照本公司所附《保修证》的规定进行修理。

产品清单

- | | |
|-----------|----|
| ① 主机（含袖带） | 1台 |
| ② 收藏盒 | 1个 |
| ③ 7号碱性电池 | 2节 |
| ④ 使用说明书 | 1本 |
| ⑤ 保修证 | 1张 |
| ⑥ 合格证 | 1张 |
| ⑦ 血压测量记录表 | 1张 |

※随机电池为试机用电池。是为了在购买时确认商品的功能时使用的。

目录

安全注意事项	1
各部名称	3
准备	4
<ul style="list-style-type: none"> ●测量前的准备 …………… 4 ●设定日期·时间 …………… 5 ●卷绑袖带 …………… 6 	
使用方法	7
<ul style="list-style-type: none"> ●正确测量须知 …………… 7.8 ●测量方法……………9~13 ●测量值的记忆和调出 ……………14~16 ●早与晚最高血压平均值的比较……… 17 ●设定(确认)测定提示时间……… 18~20 	
其它	21
<ul style="list-style-type: none"> ●使用结束后…………… 21 ●测量时的注意点…………… 22 ●Q&A ……………23~25 ●防止故障…………… 26 ●发生异常时 …………… 27~28 	
规格……………	29

各部名称

请确认商品

主机



收藏盒

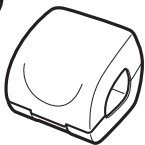

根据需要,有时会在没有事先声明的情况下,改变产品及零部件的规格。

【电池寿命】

- 如果使用一组新的Panasonic碱性电池,约可进行300次测量。
1日测量3次,约可使用3个月(室温23°C、加压至170mmHg(22.7kPa),手腕周长约17.0cm时)
- 如果环境温度较低,则会缩短电池寿命。
- 随机电池用于购买时确认商品的功能,使用寿命可能达不到300次。
- 使用碱性电池以外的电池时,使用次数可能很短,因此请务必使用碱性电池。
- 更换电池时,必须使用同一类型的新电池,2节电池应同时更换。
- 长时间不使用时,请将电池取出。避免因电池漏液而导致主机出现故障。
- 废弃电池请勿乱扔,注意回收。

准备

测量前的准备

※请务必使用碱性电池。

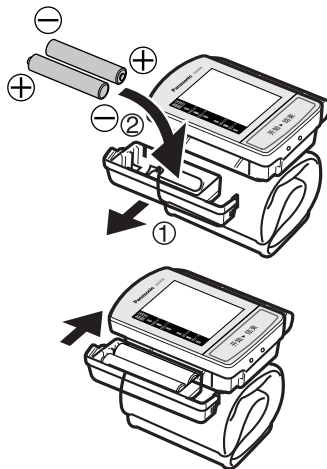

1 装入电池

- ①将电池盒沿箭头方向卸下。
- ②确认电池的⊕⊖极后,再装入2节7号碱性电池

2 安装电池盒

将电池盒平滑地推入滑道,固定在主机上(直至听见“咔哒”声)

注意



务必遵守

- 务必遵守电池上所表述的注意内容。
- 确认电池的⊕⊖极后正确地装入。
- 电量不足的电池立即取出。
- 长时间不使用本血压计时,应从血压计中取出电池。
- 请使用有效期限内的电池。
如不遵守上述事项可能因电池发热、破裂、漏液而发生伤害或破损。

更换电池

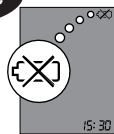

- 测量过程中显示屏出现左图显示时。
- 按下开始▶结束按钮,显示器无任何显示时。

准备

设定日期·时间

※初次使用或更换电池时，请先设定日期·时间。
(如不设定日期·时间而测量后，日期·时间处为「-:--」显示。)

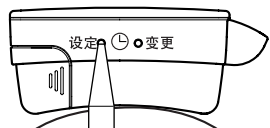

- 1 持续按设定按钮
3秒钟以上使「日」显示闪烁。

时间已经被设定时，如果按的时间短，则显示提醒音的设定画面。

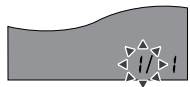

- 2 调整「日」
①按设定按钮，使「日」的数字闪烁。
②按变更按钮，调整数字。



- 3 调整「月」
按变更按钮，调出月份。



- 4 调整「时」
①按设定按钮，使「时」的数字闪烁。
②按变更按钮，调整数字。



- 5 调整「分」
①按设定按钮，使「分」的数字闪烁。
②按变更按钮，调整数字。



- 6 按设定按钮，设定完成
●约2秒钟后，日期、时间交替显示。

- 7 按开始/结束按钮，关闭电源

日期或时间闪烁时，时钟处于停止状态。

闰年的2月29日因被显示为3月1日，因此请重新设定日期。按设定·变更按钮时，请用圆珠笔等的尖端部位轻轻地按。

准备

卷绑袖带



- 1 将袖带卷绑在手腕内侧
●卷在裸露的肌肤上
●可测量的手腕周长约为12.5cm~22.0cm



- 2 绑牢袖带
●如果卷绑松弛，则导致所测的血压值偏高。
●袖带卷绑时，避免搭扣歪斜、扭曲。

●松开搭扣时，应向正侧面平行揭开，不要拧着强拉硬拽。

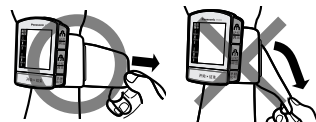

在用右手测量时

请按图示绑卷



左右手任何一侧都可以测量。但是，左右手的血压差值可能约有10mmHg，因此，每次都请用相同侧手腕测量。

使用方法

正确测量须知

每天在同一时间，用同一只手腕、相同姿势进行血压测量

- 请在早晨刚刚醒来，没有尿意时测量；如果不能保证这种状态，请在进早餐前，身体尚未运动时测量。

测量前请务必保持4~5分钟的安静

坐姿测量

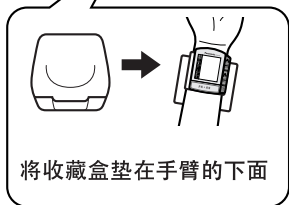

1 将胳膊肘放在桌子上

2 将主机与心脏高度保持一致

3 手心向上
身体放松

如用下图所示的手腕形态测量时，不能得出正确的血压值。

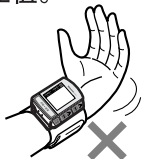

向内侧弯曲



用力握手

使用方法

正确测量须知

主机的位置低于心脏的高度时，所测得的血压值可能偏高。



主机的位置高于心脏的高度时，所测得的血压值可能偏低。



腹部收缩的姿势(前倾的姿势)不能正确的测量。



测量过程中，不得碰触主机。



测量过程中，身体、手腕、手指勿动。



测量过程中，请勿说话。

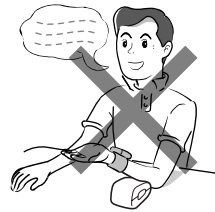

测量过程中请勿将手机等可发出电磁波的机器靠近主机。否则有可能引起误动作。

使用方法

测量方法

测量时应保持安静，使身体处于自然放松状态。



1 将收藏盒置于被测手腕下部

(为了正确测量，请参照第7,8页)

2 按开始▶结束钮

- 约2秒钟全显示。
- 自动加压。

因为是在加压时测量，所以在加压过程中动作音、加压速度等会发生变化，这并不是异常现象。

- 如果在加压过程中检测到脉搏时，「♥」符号闪烁。
- 如设定了测量提醒时间，则「△」显示。(设定(确认)测量提醒时间，参照第18~20页)

3 测量结束后，发出提醒音显示血压值及脉搏数

- 袖带内空气自动排出
- 测量结果以mmHg(血压值)、kPa(血压值)交替显示。脉搏数与血压值同时显示。测量值在高血压区域时，数字闪烁(约6秒钟)(血压指示的读法参照第12页)
- 「△△」标记显示。(存储测量值参照第14~16页)
- 测得的脉搏数以1分钟进行换算。

4 关闭电源时，按开始▶结束钮

- 即使忘记关闭电源，约5分钟后，电源也会自动关闭。

使用方法



测量方法

关于「体动提示」的功能

测量过程中，如果卷绑了袖带的手腕发生无意中弯曲等动作时，有时将不能得到正确的测量值。

- 「体动提示」是指测量过程中，手或手腕等活动向袖带施加了多余的压力时，通过「体动提示」标记和警告音提示的功能。
- 如果「体动提示」标记闪烁，请将手臂恢复到正确的姿势(参照第7,8页)
- 身体活动时的血压判定显示「体动提示」标记闪烁。有体动时的测量值显示时，「体动提示」标记也闪烁。

(存储的有体动时的测量值，在调出时「体动提示」标记也显示)

「体动提示」标记显示	警告音	说明
 闪烁	哔—哔— (长音)	感知身体活动 ●无意中弯曲手或手腕 ●手或手腕用力较大 ●手或手腕活动时 等 请恢复到正确的姿势再次测量 (参照第7,8页)
 显示	哔哔哔哔 (短音)	导致测量值产生较大差异的动作 ●大幅度动作 ●多次动作 ●手或手腕较大动作 等 显示部显示标记“E”时，请再测量。 ※如下状态时(画面显示“E”) ●袖带尼龙搭扣松开

※此功能是为正确测量而设置的参考性功能。

为了正确的测量血压，建议即使“体动提示”标记()未闪烁时，也请您在安静状态下测量2~3次。(参照第7,8页)

使用方法

测量方法

关于「心率不齐」提示的功能

是指在测量过程中，当检测到心率与平均值之间差大于±25%的脉搏时，测量结束后会出现“心率不齐”标记，来提醒使用者。

- 测量结束后，“心率不齐”标记在闪烁约6秒钟后显示。
- “心率不齐”标记显示时，请重新测量。
- 测量过程中如果心率变化大的话，可能影响测量值的准确性。

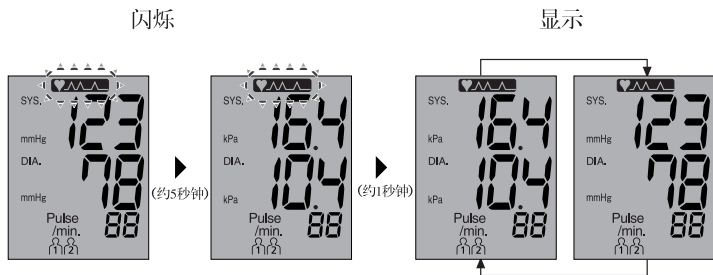

*测量结果以mmHg(血压值)、kPa(血压值)交替显示。

- 存储并调出有心率变动时的测量值时，则“心率不齐”标记显示。

该标记并非为告知心率失常的信号。

※本功能是为了保证测量值的准确性而设定的参考性功能。

即使未显示“心率不齐”标记，为了保证测量的准确性，建议在安静的状态下测量2~3次。(参照第7页)

※如果标记频繁出现，则应就自己的健康状况向医生咨询。

请勿自己判断测量结果，进行治疗。请务必遵从医嘱。

使用方法

测量方法

「血压指示」的读法

对于最高·最低血压值以WHO/ISH(世界卫生组织/国际高血压学会)的血压分类表为标准判断是属高血压区域还是属正常区域，由三种颜色的指示灯向使用者提示。

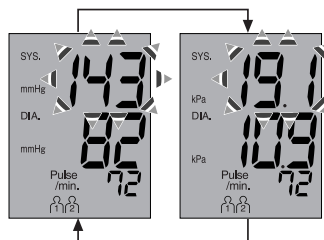
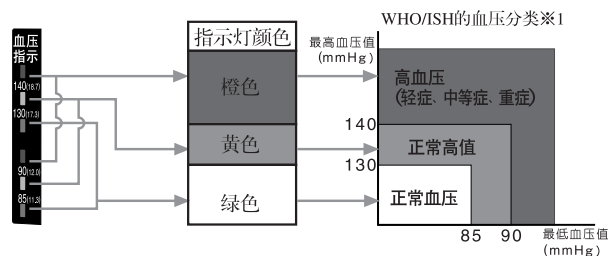

- 测量值在高血压区域时，数字闪烁。(约6秒钟)

最高血压 18.7kPa(140mmHg)以上
 最低血压 12.0kPa(90mmHg)以上
 (仅在测量结束时) (1kPa=7.5mmHg)

※1 1999 World Health Organization-International Society of Hypertension Guidelines for the Management of Hypertension

使用方法

测量方法

不能正确测量时



显示重新测量符号“E”

继续测量时，按下开始▶结束钮暂时关闭电源，请务必静候4~5分钟后再进行测量。

建议

与第一次相比，第二次测量时的状态更加平稳，血压也会有所回落。特别对于易紧张类型的人，两次记录更为有效。二次测量时，通常记录数值较小的测量值。第二次测量时，请在第一次测量后务必安静4~5分钟。

使用方法

测量值的记忆和调出

测量值的记忆 本产品可存储2人的测量数据各90组。

- 在电池电量不足时、更换电池时、取出电池的情况下，记忆内容仍可以被保存。
- 未设定时间而测量时，日期·时间为[-/- -:-]显示。

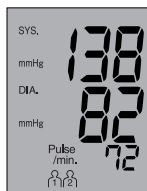

1 测量结束后，「」 「」 标记显示，按记忆/调出钮。

(例) A先生... 选择 存储
B先生... 选择 存储

2 存储完毕

- 可记忆90个测量值。此后再存入新数据时，最先输入的数据将被取代。测量值的序列号变更。
- 不能正确测量时（血压值显示「E」），测量值无法存储。测量值的序列号也不变更。
- ※但是，脉搏值显示「E」时，测量值仍可以被存储。
- 以约2秒的间隔，交替显示存储序列号/测量时间/测量日期。

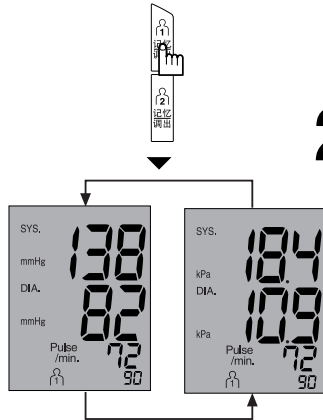

使用方法

测量值的记忆和调出

测量值的调出

记忆测量值后或切断电源的状态下，
均可以调出

1 按记忆/调出钮

- 显示所记忆的全部测量值的平均值
- 「Avg.」标记显示
- 例：如果所记忆的数据为90个，则显示90个数据的平均值。
(仅记录1个数据时,「Avg.」标记不显示。)
- 血压值指示灯亮(约6秒)

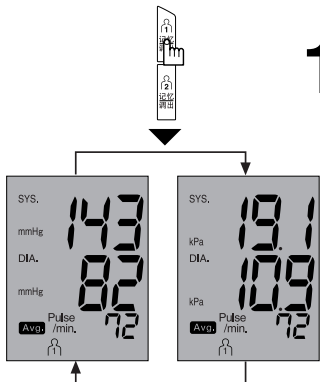

2 如果再按一次记忆/调出钮，则显示最新的测量值。

- 每按一次记忆/调出钮，则从最新的测量值开始依次显示。
- 以约2秒的间隔，交替显示序列号、测量时的日期和时间。

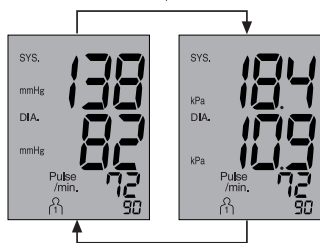



使用方法

测量值的记忆和调出

开始▶结束

- ### 3 关闭电源时，按开始▶结束钮
- 即使忘记关闭电源，约30秒钟电源也会自动关闭。

若想删除所记忆的全部测量值时

- ①按记忆/调出钮调出所记忆的测量值。
- ②持续按住记忆/调出钮约3秒钟以上，直至测量值消失。
※测量值不能逐个地删除。
- ③所有数据一但被删除则显示「」或「」标记和「00」标记，并且发出“哔哔”的蜂鸣声。

早与晚最高血压平均值的比较

显示早晨和夜间的平均最高血压，可以比较早晨与夜间各时间段的测量值。

通过使用早晚比较功能，能够帮助您尽早发现早晨血压急速升高型的早高血压症。

但是，如果不设定日期/时间的话，则无法比较。

★测量值存储后，在电源关闭的状态下也可进行比较。

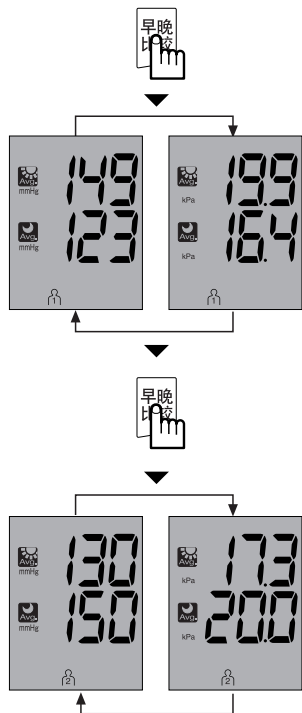

1 按早晚比较钮。

- 显示测量者1的早晨平均最高血压与夜间平均最高血压。

早晨的时间段：上午 3: 00~上午 11: 00
夜间的时间段：下午 18: 00~上午 2: 59

- 显示上面时间存储的最高血压值的平均值。
- 如没有设定时间时，以及存储的测量值低于2次时，测量值显示为「---」。

2 再次按早晚比较钮。

- 显示测量者2的早晨与夜间的平均最高血压。
- 每按一次按钮，交替显示测量者1与测量者2的早晨与夜间的平均最高血压。

3 结束时，按开始▶结束钮。

- 即使忘记关闭电源，约30秒后，电源也会自动关闭。

使用方法

设定(确认)测量提醒时间

每天请在同一时间进行测量，1天可设定3个提醒时间。

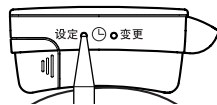

1 按设定按钮

- 提醒时间1闪烁。
- ※未设定日期·时间时，按3秒钟以上则显示日期·时间的设定画面。(请参照第5页)



2 再按1次设定按钮

- 「1」和「off」显示闪烁。



3 按变更钮，使「on」显示闪烁

- 「1」与「on」显示闪烁。
- 「on」⇒ 提示音处于开启状态。
- 「off」⇒ 提示音处于关闭状态。
- 使「on」显示，按设定钮，时间显示为「0:00」同时，「1」与「on」显示。



4 ①按设定钮，使时钟的「时」闪烁。

- ②按变更钮，调整数字。

使用方法

设定(确认)测量提醒时间



- 5** ①按设定钮,使时钟的「分」闪烁。
②按变更钮,调整数字。
- 只设定1个提醒时间时,按开始/结束钮。
 - 设定2~3个提醒时间时,按照6、7的顺序设定。



- 6** 按设定钮,提醒时间2闪烁后,按2~5的顺序,调整提醒时间。



- 7** 提醒时间2的设定结束后,按设定钮,提醒时间3闪烁后,按2~5的顺序,调整提醒时间。



- 8** 提醒时间3的设定结束后,按设定钮,提醒时间1~3的内容,每2秒钟自动变换显示。

- 9** 结束设定时,按开始/结束钮。

使用方法

设定(确认)测量提醒时间

变更提醒时间

- 1 按主机上面的设定钮(提醒时间1闪烁)
 - 变更提醒时间2或3时,按变更钮,使2或3显示。
- 2 按2次设定钮,使时钟的「时」闪烁。
- 3 按变更钮,调整数字。
- 4 ①按设定钮,使时钟的「分」闪烁。
②按变更钮,调整数字。
- 5 按开始/结束钮,设定结束。

关闭提醒音

- 1 按主机上面的设定钮(提示时间1闪烁)
 - 变更提醒时间2或3时,按变更钮,使2或3显示。
- 2 按1次设定钮,「△」与「on」闪烁。
- 3 按变更钮,「off」显示。
- 4 按开始/结束钮,设定完成。

- 到了设定的提醒时间,提醒音发出,提醒您测量血压。
- 到了设定的提醒时间时,如正在测量,则提醒音不会发出。
- 按开始/结束按钮,提醒音即刻停止。
如果不按开始/结束按钮,1分钟后提醒音自动停止。
- 放在皮包或抽屉中时,有时听不到提醒音。
- 更换电池时,以前设定的时间保持不变。

建议:

将测量值填入记录表时,请将相同时间带的值并列,则每天自己的血压变化情况就一目了然。

收藏血压计时

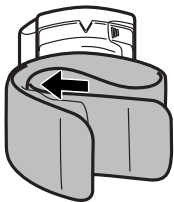

1 按箭头所示方向，**折叠袖带**



2 放入收藏盒中
• 防止袖带被收藏盒所夹。

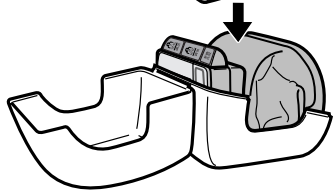

如下场合时无法测得准确的血压

饭后1小时以内
或饮酒以后

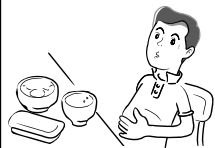

喝咖啡、红茶、
吸烟后



在运动的交通工
具中



运动或洗浴后



请安静20分钟以后再进
行测量。

在寒冷的场所测量



请在20℃左右的室温中
进行测量。

有尿意时



排尿后，请等待几分钟
后再进行测量。

手腕与上臂的血压差



对于有糖尿病、肝病、肾病、动脉血管硬化、高血压症等手足的血液循环状况不佳者^{*2}、末梢循环障碍者，手腕部血压值与上臂部血压值可能有较大差异。

所以，不可自行判断，必须接受医生的指导。

*2 由于存在基础疾患，因此手脚部分血液循环不畅的人。

Q 在医院测量的血压值和在家里测量的血压值为何不同？

A. 血压在24小时之内都在变动，另外由于气候、情绪、运动等原因有时会有较大的变动。特别是在医院里有所谓的「白衣性高血压」现象，由于紧张或不安有时比在家里测量的血压值高。

在家里所测量的血压值比在医院高时，请注意以下几点：



① 主机的高度是否与心脏在同一水平线。
主机的位置比心脏低时，所测量的血压值偏高。



② 袖带卷绑太松弛。
将袖带绑紧在手腕上。



③ 是否感到不安或焦虑。
测量前请深呼吸2~3次，放松下来使血压稳定。

Q 为什么每次测量的血压值都不一样？

A.

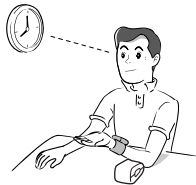

- ① 血压即使在一天之内也在不断地变化，同时也会因袖带的卷绑方法、测量姿势不同而不同。所以每次测量时，请在相同的条件下测量。
- ② 服用降压药的人，因药效的作用，血压值有时变化很大。
- ③ 连续2次测量时，中间必须安静4~5分钟以上。

Q 用左右手测量时，测量值是否相同？

A.

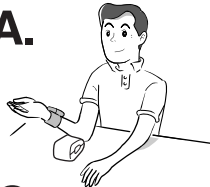

左右手任何一侧都可以测量。但是，左右手的血压差值可能约10mmHg，因此，每次都请用相同侧手腕测量。

Q 手或手腕虽动，但是「体动提示」标记不显示？

A. 所谓「体动提示」，是指在测量过程中，手或手腕等活动向袖带提供了多余的压力时，通过此标记提示的功能。

因此当做对袖带没有影响的动作（如：轻轻转肘部等）时，有可能「体动提示」标记不显示。

如果您对测量值有疑问，请重新测量。

Q 经「体动提示」的提示，修正了手或手腕位置，但测量值偏高？

A. 「体动提示」仅仅是对测量姿势是否正确的一种参考提示。（参照第10页）

「体动提示」标记显示后，测量值还是偏高或偏低时，请再次测量。出现上述情况时，可考虑以下因素：

- 测量是否正确（袖带的卷法、姿势等）
（请参照第6~8页）
- 吸烟后马上测量
- 情绪不稳定时
- 寒冷的环境
- 脉搏变化小的人
- 如果您对测量值有疑问，请安静4~5分钟后再次测量。

Q 何时测量较好?

A. 一天中测量3次比较好

第一次... 起床时(最接近夜间的血压,且基本无因身体的活动而产生的影响。)

第二次... 中饭前(无饮食的影响,且最接近一天中的最高血压值)

第三次... 就寝前(测量值最接近一天中的血压平均值)

通过早、中、晚的测量,掌握自己的血压状态,轻松管理自己的血压。

使用方法的建议(请参照第17~19页)

- 请在使用时,将提醒时间设定为上述时间。
- 通过使用早晚比较功能,能够帮助您尽早发现早晨血压急速升高型的早高高血压症。

请勿自行修理、拆卸和改造。



切勿反方向弯曲袖带。袖带仅用于测量血压时卷绑手腕。

● 否则会造成袖带破损



请勿将主机摔掉在地上,避免受到碰撞或强烈冲击。

● 否则会造成故障



切勿沾染异物或腐蚀性液体。

● 否则会造成故障



请不要将血压计从0°C以下的场所取出后马上使用。

至少要在温暖环境下放置1小时以上

● 否则会造成不能正常加压



测量时请勿触碰主机。

● 否则不能正确测量



除了使用沾有温水或肥皂水的布以外,勿用酒精、汽油、稀释剂进行擦拭。

● 否则会导致变色



长时间不使用时要取出电池。(1个月以上)

● 否则会产生漏液而造成器具损坏

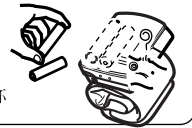

袖带不能冲洗。



避免把血压计存放在高温、潮湿以及阳光直射的场所。

● 否则会造成故障



其它

发生异常时

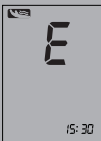
显示	异常现象	原因及处置
「再测量」的“E”显示 	▶ 加压至280mmHg以上	▶ 测量方法或姿势是否正确？ (参照第7,8页)
	▶ 压力急速下降，显示出“E”。	▶ 袖带卷绑是否正确？ (参照第6页)
	▶ 心脏标记(♥)仅闪烁数次(或完全不闪烁)	
	▶ 不加压	
	▶ 手和手腕大幅度活动。	▶ 是否检测到体动 (参照第10页)

仍存在异常时

症状	可能的原因
▶ 最高血压值或最低血压值偏高或偏低	<ul style="list-style-type: none"> • 测量时，主机的位置相对于心脏的高度偏高或偏低 • 袖带没有正确卷绑 • 测量时出现动作或讲话 (参照第6~8页)
▶ 与医生测量的血压值不一致	<ul style="list-style-type: none"> • 血压因在医生面前等微妙的心理状态而变化。 • 至少放松4~5分钟以后再重新进行测量。 (参照第7~8页)
▶ 每次测量的血压值都不一致	

仍存在异常时

请接受医生的指导

其它

发生异常时

症状	可能的原因
▶ 即使按开始▶结束钮也无显示	▶ 电池⊕/⊖极安装错 (参照第4页)
▶ 按开始▶结束钮，全显示后，显示消失。(⊗标记显示)	▶ 电池消耗完毕 (参照第4页)
▶ 测量过程中，「♥」标记闪烁。	▶ 测量过程中，心率发生大的变化。 (参照第11页)
▶ 测量过程中，「🖐️」标记闪烁。	▶ 手或手腕移动 (参照第10页)
▶ 手或手腕未动，但「🖐️」标记闪烁。	▶ 有时手上用力时也会有反应，请在放松状态下测量。 (参照第10页)
▶ 加压过程中声音和加压速度变化	▶ 因为是在加压过程中测量，因此在加压过程中动作声音与加压速度出现变化，这并不是故障。
▶ 主机破损	敬请协作 请勿自行修理，并请务必委托本公司指定的电子血压计技术服务代理店进行检查、修理。

仍存在异常时

规格

电 源	DC3V 7号碱性电池2节	
显示方式	数字式液晶显示	
测量方式	示波法检测方式	
测量范围	压 力: 0kPa~37.3kPa(0mmHg~280mmHg) 脉搏数: (30~160)次/分	
准 确 度	压 力: 15℃~25℃ ±0.4kPa(3mmHg)以内 5℃~40℃(15℃~25℃以外) ±0.8kPa(6mmHg)以内 脉搏数: ±5%以内	
加 压 速 度	0.5kPa/s~1.1kPa/s(3.75mmHg/s~8.25mmHg/s)	
正常工作环境	温 度	5℃~40℃ 相对湿度 ≤ 80%
贮存运输环境	温 度	-20℃~55℃ 相对湿度 10%~93%
可测量的手腕周长	约12.5cm~22.0cm	
重 量	约116克 (不含电池)	
外形尺寸(主机)	长78mm×宽63mm×厚26mm	
安全分类	内部电源B型	
加压方式	振动片式泵的加压调整方式	
快速排气方式	急速排气阀开放方式	
压力检测	半导体压力传感器	
脉搏检测	半导体压力传感器	
企业标准号	Q/DXBSX005-2007	
注册标准号	YZB/京0059-2007	
医疗器械生产企业许可证号	京药监械生产许20000034号	

*如果在规定的温度和湿度范围外储存和使用,可能无法达到规定的性能规格。

部件名称	有毒有害物质或元素					
	铅 (Pb)	汞 (Hg)	镉 (Cd)	6价铬 (Cr(VI))	多溴联苯 (PBB)	多溴二苯醚 (PBDE)
外壳	○	○	○	○	○	○
电路板 (蜂鸣器)	×	○	○	○	○	○
袖带	○	○	○	○	○	○
...	○	○	○	○	○	○

○ : 表示该有毒有害物质在该部件所有均质材料中的含量均在SJ/T11363-2006标准规定的限量要求以下。
 × : 表示该有毒有害物质至少在该部件的某一均质材料中的含量超出SJ/T11363-2006标准规定的限量要求。

合格证:



EW3039 Wrist Blood Pressure Monitor

- This instrument is an automatic electronic sphygmomanometer for measuring wrist blood pressure. The values of blood pressure and pulse can be easily measured by using oscillography.
- Applicable to the measurement of human body's blood pressure and pulse without traumatism.
- The wrist circumference that can be measured with this Wrist Blood Pressure Monitor is about 12.5cm-22.0 cm.

Our promise

Any malfunction occurring within of purchase will be dealt with according to the rules in Repair Card attached to the product.

Packing list

- ① Main unit (with pressure cuff) 1
 - ② Storage case 1
 - ③ AAA-size batteries 2
 - ④ User manual 1
 - ⑤ Repair card 1
 - ⑥ Certificate 1
 - ⑦ Record card for blood pressure measurement 1
- Included batteries are for device testing. Please verify the functions of the device during purchase.

Content

Important Safety Instructions	31
Parts Identification	32
Preparation	33
• Preparations Before Measurement	33
• Setting the date and time	34
• Positioning The Cuff	35
How to Use	36
• Instructions for correct measurement	36~37
• Methods of measurement	38~41
• Save and read measured values	42~44
• Comparison of average values of highest morning and evening blood pressures.	45
• Set (confirm) prompt time for measurement.	46~48
Other	49
• After Use	49
• Cautions During Measurements	50
• Q&A	51~53
• Care And Maintenance	54
• Troubleshooting	55~56
• Specifications	57

IMPORTANT SAFETY INSTRUCTIONS

- * Before using this instrument, please read the "IMPORTANT SAFETY INSTRUCTIONS" and be sure to use the instrument properly.
- * The cautions in this section are intended to instruct you in the proper use of this instrument and prevent danger or injury to yourself or other people.

All of the cautions contain important information regarding safety and must be followed.

WARNING: Failure to follow the caution may result in death or serious injury of people.

CAUTION: Failure to follow the caution may result in injury to people, or in damage to property.

WARNING:

Persons with serious obstructions of blood flow in the arm should consult a doctor before using this instrument. Failure to do so may result in deterioration of physical condition.

CAUTION:

- Do not make judgements yourself regarding the measurement results or self-treat yourself.
- There will be large differences between wrist blood pressure values and upper-arm blood pressure values for persons with periphery circulatory obstruction due to diabetes, liver disease, kidney disease, arteriosclerosis, high blood pressure, etc.
- Take measurements according to your doctor's instructions and have your doctor do the diagnosis.
- Take medicine according to your doctor's instructions.
- Do not use for purposes other than the measurement of blood pressure. Doing so may result in an accident or malfunction.
- Do not use this instrument on infants or on people who cannot express their feelings. Doing so may result in problems or an accident.
- Do not disassemble this instrument, or attempt to repair or modify it yourself. Doing so may result in an accident or malfunction.

SAVE THESE INSTRUCTIONS

PARTS IDENTIFICATION

Please check the instrument.

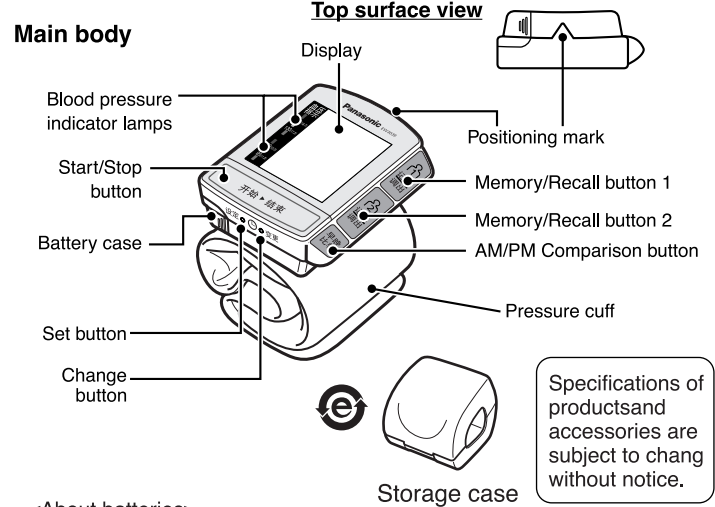

<About batteries>

- Panasonic alkaline batteries (two AAA-size batteries) can provide approximately 300 uses (for measurements 3 times a day, approximately 3 months of use). (Measurement conditions: Room temperature: 23°C Pressurized to 170mmHg; Wrist circumference: 17cm)
- Batteries are included only for testing purposes and with no guarantee of battery life. (In some areas batteries are not included with the unit.)
 - If the measurement notification sound is used, battery life will be shorter.
 - At lower room temperatures, battery life will be reduced.
 - When using batteries other than alkaline batteries, the number of uses may be greatly reduced. Always use alkaline batteries.
 - When installing batteries, both batteries should be of the same type and from the same manufacturer, and should be installed together at the same time.
 - If the instrument will not be used for a long period of time, remove the batteries. Leaving the batteries installed may result in battery leakage and damage to the instrument.
 - Do not discard batteries with normal garbage. Take to recovery center.

PREPARATIONS BEFORE MEASUREMENT

* Always use alkaline batteries.

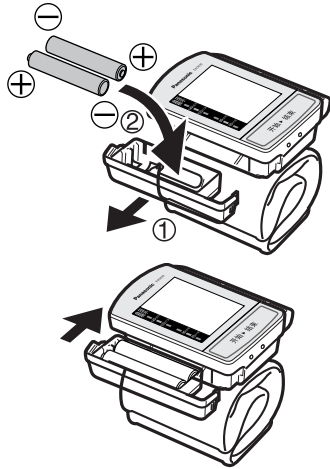

1 Remove the unit from its storage case.

Inserting dry cell batteries.

- (1) Remove the battery case by pushing it in the direction of the arrow.
- (2) Insert the batteries, ensuring the correct polarity.

2 Slide the battery case back into place on the main body until it clicks into place.

Replace batteries when:

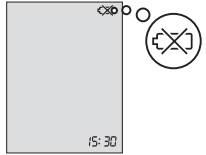

- The mark shown at right appears during measurement.
- No display is shown when the Start/Stop button is pressed.

⚠ CAUTION:

- Always follow the cautions printed on the batteries.
 - Check the polarities of the batteries and install them correctly.
 - Promptly remove exhausted batteries.
 - If the product will not be used for a long time, remove the batteries.
 - Batteries should be used before their expiration date.
- Use after the expiration date may result in injury or staining of the surrounding area due to generation of heat, bursting, or leakage.

SETTING THE DATE AND TIME

* Please be sure to set the date and time before taking the first measurement after purchasing the blood pressure monitor or after changing the batteries. (If a measurement is taken without setting the date and time, r:--:-- will be displayed.)

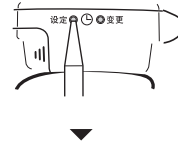

1 Hold the **設定** button on bottom surface of the monitor pressed **for at least 3 seconds**. The day value will blink.

If the date and time have already been set and the button is not held pressed long enough, the display will change to the measurement notification sound setting display.



2 Set the day.

Press the **変更** button repeatedly to set the correct day.



3 Set the month.

Press the **設定** button. The day value will blink. Press the **変更** button repeatedly to set the correct month.



4 Set the hour.

Press the **設定** button. The hour value will blink. Press the **変更** button to set the correct hour.



5 Set the minute.

Press the **設定** button. The minute value will blink. Press the **変更** button repeatedly to set the correct minute.



6 Press the **設定** button at the exact time the minute changes **to finalize** the date/time setting.

7 Press the **开始/结束** button to **switch off** the power.

When date and time are blinking, the clock has stopped.

Feb 29 of leap year is displayed as Mar 1, so please reset the date. Please use the tip of a ballpoint pen to press the buttons of "設定" and "変更" lightly.

POSITIONING THE CUFF

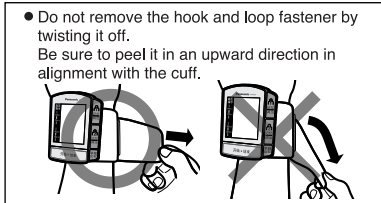
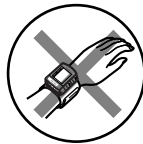
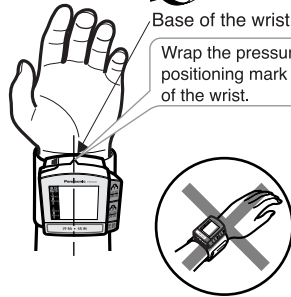
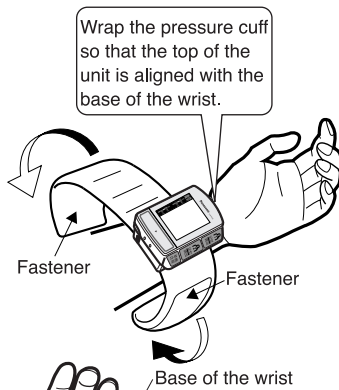

1 Attach on the inside of the wrist.

- Wrap the cuff on bare skin.
- Measurable wrist circumference: 12.5cm to 22.0cm

2 Fasten the cuff firmly

- If the cuff is wrapped loosely, the measured value for blood pressure will be high.
- Avoid twisting the belt when fastening.

When measuring on the right wrist:

Position the blood pressure monitor as shown in the figure.



The blood pressure monitor can be used by wrapping the cuff on either wrist. However, since it has been said that the difference in blood pressure between the left and right wrists may be around 10mmHg, be sure to always use the same wrist for measurements.

FOR ACCURATE MEASUREMENTS

Take measurements at around the same time every day, using the same wrist and in the same posture.

- When taking measurements in the morning, take the measurement immediately after waking up when there is no urge to urinate, or if that is difficult, take measurements before eating breakfast without moving your body.

Before measurements, be sure to sit quietly for 4 to 5 minutes.

When measuring while sitting down:

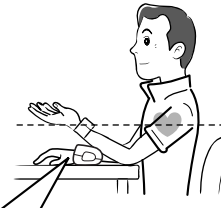

1 Rest your elbows on a table.

2 Position yourself so that the blood pressure monitor is at the same level as your heart.

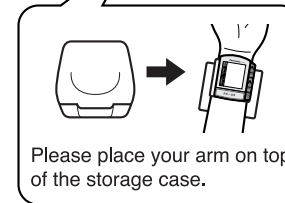

3 With the palm of the hand facing up, release any tenseness in your muscles.

If measurements are taken with the wrist or hand in the following positions, accurate measurements will not be obtained.



Wrist is bent inwards.

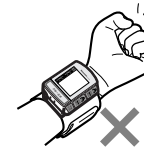

Wrist is tense and fist is being made.

FOR ACCURATE MEASUREMENTS(CONTINUED)

If the blood pressure monitor is positioned lower than the heart, the measured blood pressure value may be high.



If the posture applies pressure to the stomach (leaning forward), accurate measurements may not be possible.



Do not move your body, your arm, or your fingers while taking measurements.



Do not use the blood pressure monitor near cellular phones or other devices which emit electromagnetic waves. Doing so may result in malfunction.

If the blood pressure monitor is positioned higher than the heart, the measured blood pressure value may be low.



Do not touch the blood pressure monitor while taking measurements.



Do not talk while taking measurements.



TAKING A READING

Stay quiet and relax while taking measurements.



1 Place the storage case under your arm. (Refer to "FOR ACCURATE MEASUREMENTS" on see pp. 36 and 37.)

2 Press the 开始 / 结束 button.

- All displays will be shown for approximately 2seconds.
- Pressurization will start automatically.
- The heart mark ♥ will blink with sound when pulse is detected during pressurization.
- If the measurement notification time is set, the bell mark will be shown. (To set or check the measurement notification time, see pp. 46 to 48.)

Since measurements are performed during pressurization, there may be changes in operating sounds or the pressurization rate during pressurization. This is normal and is not a malfunction.

3 When measurement has been completed, the beeps will sound and **the blood pressure and pulse readings will be displayed.**

- Pressure will be automatically released from the pressure cuff.
- The blood pressure indicator lamps will light (for approximately 6 seconds).
- If the measured value is in the high blood pressure region, the values will blink (for approximately 6 seconds). (For how to read the blood pressure indicator lamps, see p. 41.)
- The \bar{H} or \bar{L} mark will be lit up. (For measurement values which can be stored, see p.42~44)

* The pulse rate value is the beats per minute calculated based on the pulse rate during measurement.

4 To switch off the blood pressure monitor, **press** the 开始/结束 button.

- If you forget to switch off the blood pressure monitor it will switch off automatically after approximately 5minutes.



TAKING A READING (CONTINUED)

MOVEMENT DETECTION FUNCTION

If the wrist bound with sleeve strap flexes unconsciously during the measurement, the blood pressure results may be inaccurate at times.

- The "Movement Detection Function" is a function that detects excess pressure on the wrist strap caused by movement of the user's hand or wrist during blood pressure measurement and shows the "Movement Detection" symbol in the display when this occurs.
- If the "Movement Detection" symbol blinks, please resume the proper position of your arm (see pp.36 and 37).
- The "Movement Detection" symbol will blink if the body moves during blood pressure measurement. When the result is displayed and body was moving during measurement, the "Movement Detection" symbol will also blink.

(When a saved result, measured while the body was moving, is selected, the "Movement Detection" symbol will also blink.)

"Movement Detection" symbol display	Alarm	Explanation
	Long "peep-peep" sound	Body movement detected <ul style="list-style-type: none"> • Involuntary flexure of hand or wrist. • Overexertion of the hand or wrist. • Movement of the hand or wrist etc. Please resume the right position and measure again(see pp.36 and 37).
	Short "peep-peep-peep" sound	Movement that may cause inaccurate measurement result occurred: <ul style="list-style-type: none"> • Large degree of movement • Multiple movements • Large degree of movement of the hand or wrist etc. When "E" is displayed on the screen, please measure again. ("E" will be displayed when:) <ul style="list-style-type: none"> • The fastener of sleeve strap is loose.

*This is a reference function that designed for accurate measurement. In order to obtain more accurate blood pressure measurement results, please measure for 2-3 times under static status even if the "Movement Detection" symbol does not blink (see p.36).

IRREGULAR PULSE DETECTION FUNCTION

If the heart rate measured exceeds the average value for more than ± 25% during measurement, the symbol of "Irregular Pulse" will be displayed to remind that attention is needed after measurement.

- After measurement, the symbol of "Irregular Pulse" will be displayed after 6 seconds of blinking.
- When the symbol of "Irregular Pulse" is displayed, please measure again.
- If the heart rate changes too much during measurement, it may affect the accuracy of measured value.

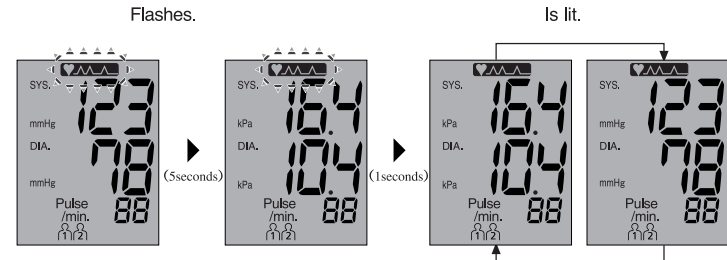

* Blood pressure values are displayed alternately in mmHg and kPa units.

- When you save and select the value measured with irregular pulse, the symbol of "Irregular Pulse" will be displayed as well.

This symbol is not designed to indicate irregular pulse.

- This is a reference function intended for ensuring the accuracy of measured value. In order to ensure the accuracy of measurement, please measure for 2-3 times under static status even if the symbol of "Irregular Pulse" is not displayed.(see.p.27)
- If the symbol appears constantly, you should consult a doctor regarding your health condition.

Please do not estimate the result and receive treatment by yourself: doctor's advice must be followed.

TAKING A READING (CONTINUED)

Reading the blood pressure display

Whether the systolic and diastolic blood pressure values are in the high blood pressure region or normal blood pressure region are judged based on the WHO/ISH(Word Health Organization/International Society of Hypertension)blood pressure classifications,and the blood pressure value blinks if required.

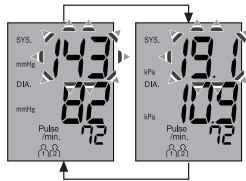
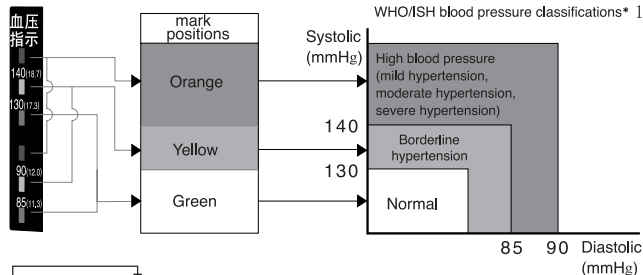

If the measured blood pressure value is in the high blood pressure region, the values will blink for approximately 6 seconds.

- Systolic blood pressure:18.7kPa (140mmHg) or higher
- Diastolic blood pressure:12.0kPa (90mmHg) or higher (Only immediately after measurement) (1kPa=7.5mmHg)

If measurements could not be taken properly



The remeasure mark "E" will be displayed.

When taking successive measurements,press the 开始/结束 button to switch off the blood pressure monitor once and stay quiet for 4 to 5 minutes,and then take the next measurement.

Advice:

Often with the second measurement,there is less tension and you feel more relaxed,so the blood pressure value is lower. For people who easily get tense,measuring twice each time is very effective. When two measurement are taken,normally the smaller measurement is stored.

When taking two measurements,always stay quiet for 4 to 5 minutes after the first measurement before taking the second measurement.

※1 1999 World Health Organization-International Society of Hypertension Guidelines for the Management of Hypertension

STORING AND RECALLING MEASUREMENT VALUES

Storing measurement values

Up to 90 readings each can be stored in the memory for two people. Stored data will remain in memory even if batteries become exhausted or batteries are removed.

If measurements were taken without setting the date and time, the date and time will be shown as "-/- -:-".

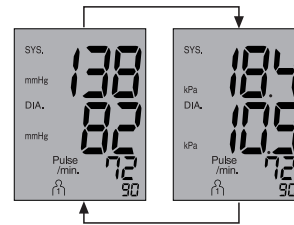
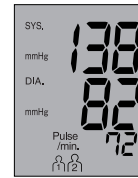

1 After measurement has been completed, the mark will be lit. Press the button for the memory in which you want to save the reading.

E.g. A....Recorded in
B....Recorded in

2 Storing is completed.

- Up to 90 measurement values can be stored. When the memory is full and additional values are stored, the oldest value in memory will be deleted and the new value will be stored. At that time, the data numbers for the measurement values will change.

- If measurements could not be taken properly (the mark is shown instead of the blood pressure value), measurement values cannot be stored. Data numbers will not be changed.

* However, if only the pulse rate value shows the , measured blood pressure values can be stored.

- The memory number, measurement date, and time are alternately displayed approximately every two seconds.

STORING AND RECALLING MEASUREMENT VALUES (CONTINUED)

Recalling measurements

Measurement values stored in memory can be recalled at a later time or after the power has been switched off.

1 Press the 记忆/调出 button of the person for whom you wish to recall a reading.

- The average of all measured values in memory will be shown.
- The mark will be lit.
- For example, if 90 measured values are stored, the average of 90 measurements will be shown. (If only 1 measurement is stored, the mark will not be shown.)
- Blood pressure indicator lamp will be lit up for approximately 6 seconds.

2 If you press the 记忆/调出 button again, the most recent stored measurement value will be shown.

- Each time the 记忆/调出 button is pressed, the stored measurement values will be recalled in order, starting with the most recent.
- Memory number, date and time of the reading will be displayed for approximately two seconds each.

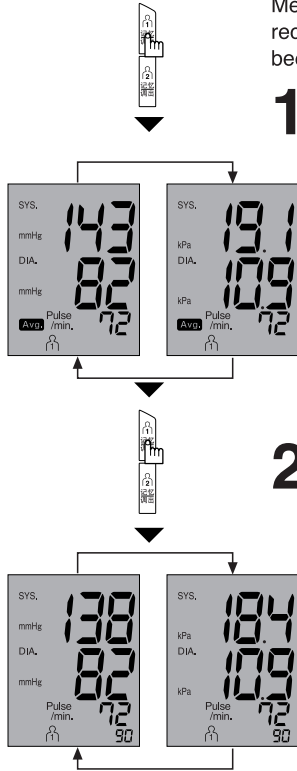

开始 ▶ 结束

3 To switch off the blood pressure monitor, **press** the 开始 ▶ 结束 button.

If you forget to switch off the blood pressure monitor, it will switch off automatically after approximately 30 seconds.

To erase all measured values stored in memory:

Press the 记忆/调出 button to recall stored measurement values.

Press the 记忆/调出 button again and hold it pressed until the measurement values disappear (longer than approximately 3 seconds).

* It is not possible to erase single measurement values.

When all measurement values have been deleted, the selected mark or mark and mark will be displayed (with sound).

COMPARISON OF THE AVERAGE VALUES OF THE HIGHEST MORNING AND EVENING BLOOD PRESSURES.

This function displays the average values of the highest morning and evening blood pressures, and the measured values of different periods of morning and evening can be compared.

This function Comparing morning and evening values can be helpful to detect morning fast-increasing pressure type of hypertension as soon as possible.

However, the comparison will be unavailable if 日期 / 时间 is not set.

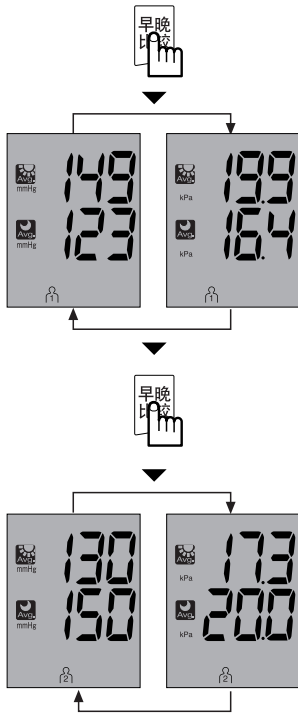

1 Press the 早晚比较 button.

- Display the average values of the highest morning blood pressure and the highest evening blood pressure of User 1.

Morning : 3:00 AM-11:00 AM
 Evening : 18:00 PM - 2:59 AM

- Display saved average value of the highest blood pressure during above periods.
- If time is not set or saved values are less than twice, the measured value is displayed as [- -].

2 Press the 早晚比较 button again.

- Display the average values of the highest morning and evening blood pressure of User 2
- Every time the button is pressed, the average values of the highest morning and evening blood pressures for User 1 and User 2 are displayed alternatively.

3 When measurement is finished, press 开始▶结束 buttons.

- Even if you forget to shut off power supply, it will be shut off automatically after 30 seconds.

SETTING (CHECKING) THE MEASUREMENT NOTIFICATION TIME

To let you take measurements at the same time every day, 3 times per day can be set as notification times.

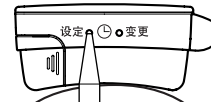

1 Press the 設定 button on the bottom surface of the blood pressure monitor.

- Notification Time 1 will blink.

* If date and time have not been set, or the button is held pressed for more than 3 seconds, the display will change to the 日期/时间 setting display.



2 Press the Set button again.

- The \triangle and OFF will blink.



3 Press the Change button to display ON.

- The \triangle and ON will blink.
 - ON \rightarrow Notification sound will sound.
 - OFF \rightarrow Notification sound will not sound.
- When ON is displayed and the Set button is pressed, the time becomes 0:00 and the \triangle and ON will light.



- ### 4
- ① Press the Set button. The hour value will blink.
 - ② Press the Change button repeatedly to set the desired hour.

SETTING (CHECKING) THE MEASUREMENT NOTIFICATION TIME (CONTINUED)



- 5**
- ① Press the Set button. The minute value will blink.
 - ② Press the Change button repeatedly to set the desired minute.
- To set only Notification Time 1, press the 开始 / 结束 button to complete the setting.
 - To set Notification Times 2 and 3, follow steps 6 and 7 below.



- 6** Press the Set button. Notification Time 2 will blink. Repeat steps 2 to 5 to set the desired notification time.



- 7** When setting of Notification Time 2 has been completed, press the Set button. Notification Time 3 will blink. Repeat steps 2 to 5 to set the desired notification time.





- 8** When setting of Notification Time 3 has been completed, press the Set button. The times set for
- 9** To complete the setting, press the 开始 / 结束 button. Notification Times 1 to 3 will be shown automatically at 2 second inter vals.

To change the notification time setting:

- 1** Press the Set button on the bottom surface of the blood pressure monitor. (Notification Time 1 will blink.)
 - To change the setting for Notification Time 2 or 3, press the Change button to display Notification Time 2 or 3.
- 2** Press the Set button twice. The hour value will blink.
- 3** Press the Change button repeatedly to set the desired hour.
- 4** Press the Set button. The minute value will blink. Press the Change button repeatedly to set the desired minute.
- 5** Press the 开始/结束 button to complete the setting.

To change the measurement notification sound:

- 1** Press the Set button on the bottom surface of the blood pressure monitor. (Notification Time 1 will blink.)
 - To cancel notification for Notification Time 2 or 3, press the Change button to display Notification Time 2 or 3.
 - 2** Press the Set button once. The  and  will blink.
 - 3** Press the Change button.  will be displayed.
 - 4** Press the 开始/结束 button to complete the setting.
- When the set time is reached, the measurement notification sound will sound to notify you that it's time to take a measurement.
 - If the set time is reached in the middle of taking a measurement, the measurement notification sound will not sound.
 - When the measurement notification sound sounds, it can be stopped by pressing the 开始/结束 button. If the button is not pressed, the sound stops after 1 minute.
 - If the blood pressure monitor is put into a bag, desk, etc., it may not be possible to hear the measurement notification sound.

Advice:

If a record table is made of the measurement values taken around the same time, you can easily see your own daily blood pressure changes.

AFTER USE

Storage

1

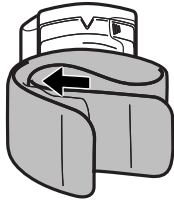

1 Fold the pressure cuff as indicated.

2

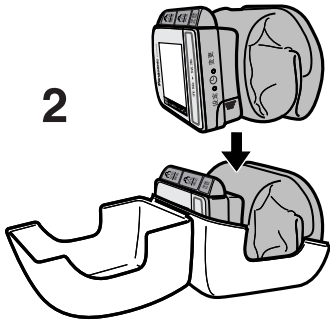

2 Put the blood pressure monitor in the storage case.

Avoid pinching the cuff with the storage case.

CAUTIONS DURING MEASUREMENTS

In the following situations, accurate measurements cannot be taken.

Within 1 hour of eating or drinking alcohol

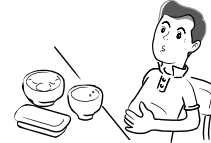

Immediately after exercising or taking a bath



Wait at least 20 minutes and take a measurement while staying quiet.

Immediately after drinking coffee or tea, or smoking



In cold places



Measurements should be taken at room temperatures of around 20°C.

In a moving vehicle



When you need to urinate



Wait several minutes after urinating before taking measurements.

Difference between wrist and upper-arm blood pressure values



There may be large differences between wrist blood pressure values and upper-arm blood pressure values for persons with periphery circulatory obstruction due to diabetes, liver disease, kidney disease, arteriosclerosis, high blood pressure, etc.*1

Because of this, do not make judgements regarding blood pressure yourself. Always follow your doctor's directions.

*1 Persons with basic diseases and poor circulation in the wrist.

Q & A

Q Why are the blood pressure values measured at home different from those measured at the doctor's office?

A Blood pressure varies 24 hours a day. In addition, it can change greatly depending on the weather, your mental state, exercise, etc.

In particular, there is the phenomenon of "White uniform hypertension" at doctor's office, where the blood pressure measured in a doctor's office is higher because of stress or worry.

In addition, if the blood pressure measured at home is higher than that measured at the doctor's office, the following points should be considered and care should be observed where necessary:



- ① The blood pressure monitor is not at the same height as the heart.
If measurements are taken with the blood pressure monitor lower than the heart, the measured blood pressure values will be higher.

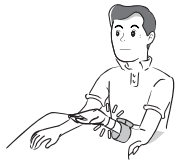

- ② The pressure cuff is wrapped loosely.
Wrap the pressure cuff securely around the wrist.



- ③ Do you feel worried or irritated?
Before taking measurements, take 2 or 3 deep breaths and relax to stabilize blood pressure. In addition, it is recommended that you sit quietly for about 4 to 5 minutes before taking measurements.

Q & A

Q Why are measured blood pressure values different each time I take a measurement?

A

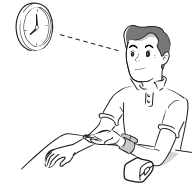

- ① Blood pressure varies throughout the day, and can also vary depending on how the pressure cuff was wrapped or your posture. Because of this, measurements should be taken at the same time and under the same conditions every day.
- ② For persons taking blood pressure medication, blood pressure may change greatly due to the effects of the medication.
- ③ When taking 2 measurements in succession, be sure to stay quiet for 4 to 5 minutes after the first measurement before taking the next measurement.

Q Why are the measured values different for the left and right wrist?

A

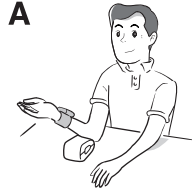

It is said that differences in blood pressure values between the left and right wrists may be around 10 mmHg. The blood pressure monitor can take measurements on either the left or right wrist, but all measurements should be taken using the same wrist.

Q The "Movement Detection" symbol is not displayed while the hand or the wrist is moving. why?

A The "Movement Detection Function" is a function that detects excess pressure on the sleeve strap which is caused by movement of the user's wrist during measurement and displays the "Movement Detection" symbol when this occurs. Because of this, the "Movement Detection" symbol may not be displayed if the movement does not affect the sleeve strap.

If you are unsure about the measurement, please do it again.

Q & A

Q The measured value is unusually higher although the position of the hand and the wrist is fixed according to the "Movement Detection" symbol. Why?

A The "Movement Detection" symbol is just a reference indication for correct measurement posture (see pp.39).

If the measured value is unusually higher or lower after the symbol of "Movement Detection" is displayed, please measure again.

If the above situations occurs, the following factors may exist:

- Incorrect measurement method (the binding method of sleeve strap, posture, etc)?

Please refer to the methods of pp.36 ~ 37.

- Measurement immediately after smoking.
- Measurement when user's mood is not steady.
- Measurement in cold circumstance.
- The change of user's pulse is small.

If you are unsure about the measured value, please measure again after 4-5 minutes rest.

Q When should I measure my blood pressure?

A We recommend that you measure your blood pressure 3 times a day.

First time: When you get up in the morning. (This is when your blood pressure is most typical of its value during the night and when the movements of your body have had hardly any effect on it.)

Second time: Before eating lunch. (This is when your blood pressure is not affected by food and when it is most typical of the highest level of the day.)

Third time: When you go to bed at night. (This data value is roughly typical of the average blood pressure value for the day.)

Get to know your blood pressure pattern by measuring your blood pressure in the morning, at midday and in the late evening, and use the data you obtain to manage your blood pressure.

Suggestions of use methods (Please refer to page 45~ 47)

- Please set the prompt time as the time mentioned above when using.
- By using the function of comparing morning and evening values, it is helpful to detect morning fast-increasing pressure type of hypertension as soon as possible.

CARE AND MAINTENANCE

Do not disassemble the instrument or attempt to repair or modify it.

Always wrap the pressurization cuff around the wrist for use. Do not bend the pressurization cuff backwards.

- Doing so may damage the pressurization cuff.

Do not apply excessive force to the instrument or drop the instrument.

- Doing so may cause damage.

Do not insert dust or foreign objects into the instrument.

- Doing so may result in damage.

If the instrument is stored at temperatures below the freezing point, do not use it immediately. Leave it in a warm place for at least an hour before use.

- If the instrument is not allowed to warm up, it may not pressurize.

Do not touch the instrument during use.

- Doing so may prevent accurate measurements.

If the instrument becomes dirty, clean it with a soft cloth moistened with warm water or soapy water. (Do not use alcohol, benzine, or paint thinner.)

- Use of such chemicals may result in cracking or discoloration.

If the instrument will not be used for a long period of time (more than 1 month), remove the batteries.





- Leaving the batteries installed may result in battery leakage and damage to the instrument.

The pressure cuff cannot be washed.





For storage, avoid high temperatures, high humidity, and direct sunlight.

- Storage under such conditions may result in damage.

TROUBLESHOOTING

Display	Status before error	Cause and solution
Remeasure  mark is displayed. 	Pressurization to more than 280 mmHg was performed.	Were measurements taken according to the proper procedure and in the correct posture? See pp. 36 ~ 37.
	Pressure decreased suddenly and the remeasure mark  appeared.	Was the pressurization cuff wrapped properly? See p. 35.
	The heart mark  blinked only a few times or not at all.	
	No pressurization	
	Your hand or wrist moved.	Has the unit detected movement? See p. 39.

Symptom	Possible cause
Systolic or diastolic blood pressure value is high or low.	<ul style="list-style-type: none"> • During measurement, the level of the instrument was higher or lower than the level of the heart. • The pressure cuff was not wrapped properly. • You moved or talked during measurement. See pp.35 to 37.
Value is different from that measured by the doctor.	<ul style="list-style-type: none"> • Blood pressure varies in response to minute changes in your mental state, such as your reaction to the doctor's presence.
Measurement values are different with each measurement.	<ul style="list-style-type: none"> • Relax 4 or 5 minutes, and take another measurement. See pp. 36 ~ 37.

Symptom	Possible cause
No display appears even when the 开始 / 结束 button is pressed.	<ul style="list-style-type: none"> • Batteries are installed backwards. See p. 33.
When the 开始 / 结束 button is pressed, the display disappears during pressurization ( mark appears).	
During pressurization, the sound or pressurization rate changes.	<ul style="list-style-type: none"> • Since measurements are performed during pressurization, there may be changes in operating sounds or the pressurization rate during pressurization. This is normal and is not a malfunction.
The  mark flashes when readings are being taken.	<ul style="list-style-type: none"> • There was a significant fluctuation in pulse when readings were being taken. See p. 40.
The  mark flashes when readings are being taken.	<ul style="list-style-type: none"> • Your hand or wrist moved. See p.39.
The  mark flashes even though I did not move my hand or wrist.	<ul style="list-style-type: none"> • In some cases this will be displayed when you have tensed the muscles in your arm. Relax the muscles in your arm and take the reading again. See pp. 36 ~ 37.
Damage of the main part	<ul style="list-style-type: none"> • Do not repair it yourself. Please contact our designated service agency for wrist blood pressure monitors to examine and repair the device.

***The warranty of this product is only valid in the PRC (Not available in Hongkong, Macao and Taiwan for the time being)**

Specification

Power	DC3V AAA-size alkaline batteries × 2
Display mode	Digital LCD
Measurement mode	Oscillometric system
Measurement range	Pressure: 0kPa~37.3kPa(0mmHg~280mmHg) Pulse rate: (30~160)beats/minute
Accuracy	Pressure: 15℃~25℃ within ±0.4kPa(3mmHg) 5℃~40℃(out of 15℃~25℃) within ±0.8kPa(6mmHg) Pulse rate: within ±5%
Rate of pressurization	0.5kPa/s~1.1kPa/s(3.75mmHg/s~8.25mmHg/s)
Operating condition	Temperature 5℃~40℃ Relative humidity ≤ 80%
Storage & transportation condition	Temperature -20℃~55℃ Relative humidity 10% ~ 93%
Measurable wrist circumference	About 12.5cm~22.0cm
Weight	Approx. 116g (Excluding the batteries)
Dimensions (Main part)	Approx. 78mm × 63mm × 26mm
Protection against electric shock	Internally powered equipment, Type B applied part
Pressurization mode	Pressure-regulated mode of oscillating-mode pump
Fast air-discharging mode	Fast-open air-discharging valve mode
Pressure detection	Semiconductor pressure sensor
Pulse detection	Semiconductor pressure sensor

Certificate:

